

# 2018

## SPYDER

RIDING GEAR,  
ACCESSORIES  
GENUINE PARTS

2018 CAN-AM SPYDER



RIDING GEAR, ACCESSORIES & GENUINE PARTS

CANAMSPYDER.COM



**ski-doo. LYNX. SEA-DOO. EVINRUDE. ROTAX. can-am.**

**can-am** 





# GET IN THE SPYDER LANE.

Inspiration, imagination, and all that's possible - they're what drive us. Our Can-Am Spyder is proof that we never sit still, and our accessories, riding gear, and sportswear speak volumes about our commitment to endlessly enhancing the experience for all. And it all starts here... more than 112 pages filled with ideas and possibilities.

We've gone farther to include everyone who wakes up mornings hoping to climb aboard their Can-Am Spyder. We're always listening to the countless Can-Am Spyder enthusiasts who help power our innovation, inspiring us to create newer, more compelling products.

Designed for men and women alike, we've got something for every rider geared towards whatever destination you call your own. If it's comfort and fashion you're looking for, or simply want the ultimate in fit, function, style or performance it's all here. Easy to understand, and easier than ever to love.

Add our exclusive 4U Guide to complete accessory customization and it's clear: this is going to be an unforgettable year of exploration and exhilaration.

This is the place where you begin to make our Can-Am Spyder yours. We may build it, but it's fueled by your imagination.

Welcome to the all-new, all yours, ultra-enhanced Can-Am Spyder experience.

Visit us online at [canamspyder.com/shop](https://canamspyder.com/shop) or visit your preferred dealer and start enhancing your Can-Am Spyder experience.

<b>RIDING GEAR</b>	<b>2</b>	<b>SPYDER F3 ACCESSORIES</b>		<b>U-STYLE</b>	<b>84</b>
Men's & Ladies' Jackets	4	UFit System	50	Wheels	84
Jackets Technology	10	<b>U-FIT</b>	<b>51</b>	Fenders	85
Jackets - Regular Size Collection	12	Handlebars	51	Custom Accessories	86
Jackets - Plus Size Collection	15	Brake & Shifter Linkages	52	<b>U-PERFORMANCE</b>	<b>88</b>
Rain Gear	18	Idle Pulley & Footboards	53	Shocks & Silencers	88
Technical Wear	19	<b>U-FUNCTION</b>	<b>54</b>	<b>SPYDER RS &amp; ST ACCESSORIES</b>	
Helmets & Accessories	20	Seats & Backrests	55	<b>U-FUNCTION</b>	<b>91</b>
Communication Systems	26	Windshields & Wind Protection	56	Seats & Backrests	91
Footwear	28	Cargo & Storage	58	Windshields & Wind Protection	91
Protective Guards	28	Lights & Electrical Accessories	63	Cargo & Storage	93
Bags	29	<b>U-STYLE</b>	<b>65</b>	Lights & Electrical Accessories	94
Gloves	30	Wheels	65	<b>U-STYLE</b>	<b>96</b>
		Fenders	66	Wheels	96
		Custom Accessories	67	Fenders	98
		Decals	68	Custom Accessories	99
		<b>U-PERFORMANCE</b>	<b>69</b>	<b>U-PERFORMANCE</b>	<b>100</b>
		Shocks	69	Shocks	100
		Silencers	71	Silencers	101
		<b>SPYDER RT ACCESSORIES</b>		<b>CAN-AM FREEDOM TRAILER</b>	
		<b>U-FIT</b>	<b>76</b>	Can-Am Freedom Trailer	102
		Idle Pulley & Handlebars	76	Trailer Accessories	104
		<b>U-FUNCTION</b>	<b>77</b>	<b>COVERS</b>	<b>106</b>
		Seats & Backrests	77		
		Windshields & Wind Protection	78	<b>PARTS</b>	<b>108</b>
		Cargo & Storage	80	<b>OILS &amp; MAINTENANCE</b>	<b>110</b>
		Lights & Electrical Accessories	82		
		<b>CUSTOMIZED VEHICLES</b>			
F3-S	46				
F3-S	47				
F3 Limited	48				
F3-T	49				
RT	74				
RT Limited	75				



# RIDING GEAR

---

## LIFE'S BETTER WITHOUT LIMITS.

Look beyond the horizon, to all of those unseen, unexplored destinations that never seem to stop calling you. Listen to your heart and head out... anywhere. In fact, the farther the better. Don't just live your dreams; ride them - intensely, completely and without hesitation. When you're one with your Can-Am Spyder, then anywhere you're headed is home.





# LOOK AS GOOD AS YOU RIDE.



JOSH LEATHER JACKET 440740  
HANNA JACKET 440735



HANNA JACKET 440735  
LADIES' CRUISE JACKET 440734  
JOSH LEATHER JACKET 440740

HANNA JACKET 440735

JOSH LEATHER JACKET 440740





EMMA PLUS MESH JACKET 440739  
BRUCE PLUS JACKET 440678

RUSSELL MESH JACKET 440676  
LADIES' CRUISE PLUS JACKET 440752  
MEN'S VOYAGER JACKET 440641



EMMA PLUS MESH JACKET 440739



COOPER PLUS JACKET 440753



MEN'S CRUISE PLUS JACKET 440751  
NICKY PLUS JACKET 440679  
RUSSELL MESH JACKET 440676



LADIES' CRUISE PLUS JACKET 440752  
MEN'S CRUISE PLUS JACKET 440751  
KATE MESH JACKET 440736



BRUCE PLUS JACKET 440678



KATE MESH JACKET 440736  
NICKY PLUS JACKET 440679





**FIND THE RIGHT JACKET**

**WHICH JACKET SUITS YOU BEST?**

Hit the road in style, your style. There's a Can-Am jacket that fits you in every way and is loaded with the features you want. Whether you choose mesh jackets for keeping cool, leather jackets for their classic look, or ultra-durable nylon for serious road trips, we've got you covered. They're all available in a range of regular and plus sizes, for men and women, and are designed to work with our exclusive weather-beating rain gear. All you have to do is choose, and we've made that easier than ever. Whatever your destination - and whatever your riding style - you can be sure we've got a jacket that suits you perfectly.



**USE THIS GUIDE TO FIND THE FEATURES YOU WANT BY LOOKING FOR THE CORRESPONDING SYMBOL AMONG OUR EXTENSIVE COLLECTION OF JACKETS.**



**100% WATERPROOF**  
To keep dry in all conditions.



**WATER RESISTANT**  
To keep dry in light rain conditions or during short rides.



**WINDPROOF**  
To protect from air infiltration.



**REMOVABLE INSULATED LINING**  
To adapt to the current temperature. Wear when cold, remove when warm.



**POCKETS FOR REMOVABLE PROTECTORS**  
Pouches to insert removable protectors.



**ADJUSTED FIT**  
Fits closer to the body.



**RELAXED FIT**  
Looser fit for relaxed riding position.



**RPM**



**RPM MAX**

**HIGH PERFORMANCE GEAR WITH RPM TECHNOLOGY**

Critical seams and logos are sealed, so water can't enter through potential openings.



100% of seams and logos are sealed, so water can't enter through potential openings.

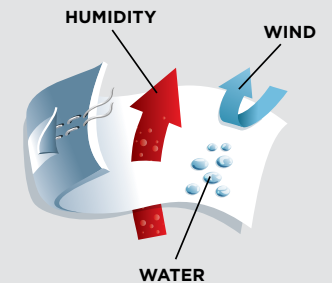

**RPM & RPM MAX** coatings keep wind and air out and still allow perspiration to escape.





REGULAR SIZE COLLECTION

# TEXTILE

▶ Learn everything about the technology built into the Cruise Jackets.  
Go to: [canamspyder.com/videos](https://canamspyder.com/videos)

## MEN'S & LADIES' CRUISE JACKETS



### FEATURES

- Teflon-treated highly wear-resistant fabric.
- Shaped sleeves.
- Action pleat gussets at back armhole for extra comfort and ease of movement.
- Critical seams sealed.
- Chest and back ventilation.
- Multi-adjustable biceps, wrists and waist openings.
- Reflective details at back.
- May require rain suit in heavy rain conditions.

Shell: Nylon, Other Fabric  
Insulation: Polyester

### BENEFITS

- Outstanding ventilation, lightweight for extra comfort.
- Breathable to keep you dry.
- Excellent flexibility and rider fit.
- Wind and water protection.
- Ultra-durability and wear resistance.
- Convenience, good practicality, and nighttime visibility.



**NEW** MEN'S CRUISE JACKET  
440733 · S, M, L, XL, 2XL, 3XL · Charcoal Grey (07)  
**\$259.99**



**NEW** LADIES' CRUISE JACKET  
440734 · XS, S, M, L, XL, 2XL · White (01)  
**\$259.99**



## HANNA JACKET



### FEATURES

- Teflon-treated highly wear-resistant fabric.
- Shaped sleeves.
- Critical seams sealed.
- Chest and back ventilation.
- Multi-adjustable biceps, forearms, wrists and waist openings.
- Reflective back collar.
- May require rain suit in heavy rain conditions.

Shell: Nylon  
Insulation: Polyester

### BENEFITS

- Outstanding ventilation, lightweight for extra comfort.
- Breathable to keep you dry.
- Excellent flexibility and rider fit.
- Wind and water protection.
- Ultra-durability and wear resistance.
- Convenience, good practicality, and nighttime visibility.



**HANNA JACKET**  
440735 · XS, S, M, L, XL, 2XL · Khaki (05), Black (90)  
**\$259.99**





# LEATHER

## JOSH LEATHER JACKET



### FEATURES

- Full grain distressed vintage cowhide leather.
- Shaped sleeves.
- Shell: Cow Leather
- Insulation: Cotton

### BENEFITS

- Flexible for better comfort and ease of movement.
- Stylish, eye-catching design.
- Convenience and practicality.



**JOSH LEATHER JACKET**  
440740 · S, M, L, XL, 2XL, 3XL · Black (90)  
\$349.99



PLUS SIZE COLLECTION

# MESH

▶ Watch the Russell and Kate Mesh Jackets' work features. Go to: [canamspyder.com/videos](https://canamspyder.com/videos)

## RUSSELL & KATE MESH JACKETS

### FEATURES

- Made of highly breathable mesh.
- No collar.
- Adjustable waist, biceps, forearms and sleeves openings.
- Shaped sleeves.
- 3M<sup>®</sup> reflective details at back.
- Shell: Polyester, Nylon
- Insulation: Polyester

### BENEFITS

- Lightweight comfort with outstanding breathability.
- Excellent flexibility and rider fit.
- Convenience, practicality, and nighttime visibility.



**RUSSELL MESH JACKET**  
440676 · S, M, L, XL, 2XL, 3XL · Black (90)  
\$199.99



**KATE MESH JACKET**  
440736 · XS, S, M, L, XL, 2XL · Black (90)  
\$199.99



# TEXTILE

## MEN'S & LADIES' CRUISE PLUS JACKETS



### FEATURES

- Teflon-treated highly wear-resistant fabric.
- Shaped sleeves.
- Action pleat gussets at back armhole for extra comfort and ease of movement.
- Critical seams sealed.
- Chest, biceps and back ventilation.
- Adjustable biceps openings.
- Reflective back collar.
- May require rain suit in heavy rain conditions.
- Shell: Nylon, Other Fabric
- Insulation: Polyester

### BENEFITS

- Outstanding ventilation and extra roominess, for comfort.
- Breathable to keep you dry.
- Excellent flexibility and rider fit.
- Wind and water protection.
- Ultra-durability and wear resistance.
- Convenience, good practicality, and nighttime visibility.



**MEN'S CRUISE PLUS JACKET**  
440751 · L PLUS, XL PLUS, 2XL PLUS, 3XL PLUS, 4XL PLUS, 5XL PLUS · Black (90)  
\$299.99



**LADIES' CRUISE PLUS JACKET**  
440752 · M PLUS, L PLUS, XL PLUS, 2XL PLUS, 3XL PLUS · Black (90)  
\$299.99







### MEN'S VOYAGER JACKET



#### FEATURES

- Parka style jacket.
- Teflon HT-treated highly wear-resistant fabric.
- Shaped sleeves.
- Action pleat gussets at back armhole for extra comfort and ease of movement.
- All seams sealed.
- Multi-adjustable biceps, forearms and waist.
- Chest, shoulder and back ventilation.
- 3M reflective details.
- May require rain suit in heavy rain conditions.

Shell: Nylon  
Insulation: Polyester

#### BENEFITS

- Outstanding ventilation and extra roominess, for comfort.
- Keeps you dry and warm all day.
- Excellent flexibility and rider fit.
- Wind and water protection.
- Ultra-durability and wear resistance.
- Convenience, good practicality, and nighttime visibility.



**MEN'S VOYAGER JACKET**  
440641 · S, M, L, XL, 2XL, 3XL · Black (90)  
**\$349.99**

### COOPER PLUS & HANNA PLUS JACKETS



#### FEATURES

- Teflon-treated highly wear-resistant fabric.
- Shaped sleeves.
- Action pleat gussets at back armhole for extra comfort and ease of movement.
- Critical seams sealed.
- Underarm ventilation (Cooper Plus Jacket).
- Reflective back collar.

- Chest, biceps and back ventilation (Hanna Plus Jacket).
  - Multi-adjustable biceps, forearms, wrists and waist openings.
  - May require rain suit in heavy rain conditions.
- Shell: Nylon  
Insulation: Polyester

#### BENEFITS

- Outstanding ventilation and extra roominess, for comfort.
- Breathable to keep you dry.
- Excellent flexibility and rider fit.
- Wind and water protection.
- Ultra-durability and wear resistance.
- Convenience, good practicality, and nighttime visibility.



**COOPER PLUS JACKET**  
440753 · L PLUS, XL PLUS, 2XL PLUS, 3XL PLUS, 4XL PLUS, 5XL PLUS · Khaki (05), Black (90)  
**\$299.99**



**HANNA PLUS JACKET**  
440754 · M PLUS, L PLUS, XL PLUS, 2XL PLUS, 3XL PLUS · Khaki (05), Black (90)  
**\$299.99**

### BRUCE PLUS & NICKY PLUS JACKETS



#### FEATURES

- Teflon-treated highly wear-resistant fabric.
  - Shaped sleeves.
  - Action pleat gussets at back armhole for extra comfort and ease of movement.
  - Critical seams sealed.
  - Chest and back ventilation.
  - Multi-adjustable biceps, forearms, wrists and waist openings.
  - Reflective back collar.
  - May require rain suit in heavy rain conditions.
- Shell: Nylon  
Insulation: Polyester

#### BENEFITS

- Outstanding ventilation and extra roominess, for comfort.
- Breathable to keep you dry.
- Excellent flexibility and rider fit.
- Wind and water protection.
- Ultra-durability and wear resistance.
- Convenience, good practicality, and nighttime visibility.



**BRUCE PLUS JACKET**  
440678 · XL PLUS, 2XL PLUS, 3XL PLUS, 4XL PLUS, 5XL PLUS  
Khaki (05) · Black (90)  
**\$299.99**



**NICKY PLUS JACKET**  
440679 · L PLUS, XL PLUS, 2XL PLUS, 3XL PLUS, 4XL PLUS  
Beige (02) · Black (90)  
**\$299.99**

## MESH

Learn more about the Shaun and Emma Plus Mesh Jackets.  
Go to: [canamspyder.com/videos](https://canamspyder.com/videos)

### SHAUN PLUS & EMMA PLUS MESH JACKETS



#### FEATURES

- Made of highly breathable mesh.
- No collar.
- Shaped sleeves.
- Action pleat gussets at back armhole for extra comfort and ease of movement.

- Adjustable waist, biceps and sleeves openings.
  - 3M reflective details at back.
- Shell: Polyester, Nylon  
Insulation: Polyester

#### BENEFITS

- Outstanding breathability and extra roominess, for comfort.
- Excellent flexibility and rider fit.
- Convenience, practicality, and nighttime visibility.



**SHAUN PLUS MESH JACKET**  
440738 · L PLUS, XL PLUS, 2XL PLUS, 3XL PLUS, 4XL PLUS, 5XL PLUS · Black (90)  
**\$249.99**



**EMMA PLUS MESH JACKET**  
440739 · M PLUS, L PLUS, XL PLUS, 2XL PLUS, 3XL PLUS · Black (90)  
**\$249.99**



# RAIN GEAR

▶ Learn the features and technologies of the Rain Jacket.  
Go to: [canamspyder.com/videos](http://canamspyder.com/videos)



## RAIN JACKET

- Made of waterproof and windproof Teflon-treated light PVC nylon.
  - Balaclava hood, sewn into the jacket, for use under the helmet while riding, to avoid water infiltration during a downpour.
  - Back ventilation for moisture evacuation.
  - Shaped sleeves.
  - Two Velcro® waist pockets with flap.
  - Reflective details at front and back.
  - Jacket folds into back pocket.
  - To wear over riding jacket, order one size up or try it on over your riding jacket to ensure it fits.
- Shell: Waterproof Nylon  
440568  
XS, S, M, L, XL, 2XL, 3XL  
Black (90)  
**\$99.99**



## RAIN PANTS

- Elasticized waist.
  - Velcro-hemmed wide side leg gusset for slipping pants on while wearing boots.
  - Elastic at bottom leg to prevent pants from riding up.
  - Folds into jacket's back pocket for easy traveling.
  - To wear the pants over clothes, order one size up or try them on over your clothes to ensure they fit.
  - Ladies: order one size smaller.
- Shell: Waterproof Nylon  
441501  
XS, S, M, L, XL, 2XL, 3XL  
Black (90)  
**\$59.99**



# TECHNICAL WEAR



## NEW WINDPROOF FLEECE

- Windproof polyester zip up jacket.
  - Also ideal for wearing as an insulating first layer on cold days.
  - Two zippered hip pockets.
  - Reflective details at front and back.
- Polyester  
Men's - 454056 - S, M, L, XL, 2XL, 3XL  
Denim Blue (79), Black (90)  
Ladies' - 454055 - XS, S, M, L, XL, 2XL, 3XL  
Warm Grey (15), Black (90)

**\$129.99**



Men's

Ladies'

## CAN-AM TECHNICAL JACKET

- Soft shell combines light insulation, breathability and weatherproofing.
  - 4-way stretch fabric.
  - Also ideal for wearing as an insulating first layer on cold days.
  - Reflective details.
  - Two hand pockets with YKK® water-resistant zipper.
  - Back venting.
  - Pre-shaped sleeves.
  - Adjustment at hem.
- Polyester, Spandex  
Men's - 453755 - S, M, L, XL, 2XL, 3XL - Black (90)  
Ladies' - 453754 - XS, S, M, L, XL, 2XL - Black (90)  
**\$99.99**



Men's



Ladies'



# HELMETS & ACCESSORIES

▶ Learn everything about the technology built into the Can-Am helmets by Nolan. Go to: [canamspyder.com/videos](https://canamspyder.com/videos)



## WHEREVER YOU GO IS THE DESTINATION.

CAN-AM N21 DURANGO OPEN FACE HELMET 448481 · DOT, 448482 · ECE

CAN-AM N104 ABSOLUTE MODULAR HELMET 448496



CAN-AM N40-5 GT CROSSOVER HELMET 448569 - DOT, 448570 - ECE



CAN-AM N104 ABSOLUTE MODULAR HELMET 448496





## CROSSOVER HELMETS

### CAN-AM N40-5 GT CROSSOVER HELMET

#### FEATURES

- **N-Com<sup>®</sup> B5 Communication System-ready.**
- Super-strong lightweight, aerodynamically-tuned polycarbonate shell with integrated spoiler.
- Exclusive Crossover technology.
- Optically-correct UV400 face shield protects the entire face while offering a large eye port and can be changed in seconds.
- Exclusive Vision Protection System (VPS<sup>®</sup>) features a scratch-resistant, antifogging, sunshield that raises or lowers in an instant.
- Innovative AirBooster<sup>®</sup> multi-vent airflow system.
- Fully removable, washable Clima-Comfort<sup>®</sup> liner, adjustable cheek pads.
- Velour-padded chinstrap with Microlock2 quick-release retention system.
- Removable protective chin guard with air intake.
- Includes all necessary accessories: chin guard plugs, side covers and helmet storage pouch.
- ECE version not available in North America.

Shell: Lexan Polycarbonate

#### BENEFITS

- Improved performance, stability and excellent high-impact resistance.
- Ultra-convenient accessory addition or replacement, maintenance, and customization.
- Added safety, exceptional field of vision and convenience.
- Protection against sun, glare, and condensation.
- Exceptional ventilation for improved temperature control.
- Anti-bacterial, anti-fungal and moisture wicking for added comfort and hygiene.
- Convenience and comfort.
- Wind noise reduction.

DOT ECE22.05



### ONE HELMET, FOUR LOOKS

QUICK-CHANGE ACCESSORIES ALLOW YOU TO CUSTOMIZE THE LOOK AND FEATURES FOR EVERY RIDE.



## OPEN FACE HELMET

### CAN-AM N21 DURANGO OPEN FACE HELMET

#### FEATURES

- Minimalist retro design.
- Super-strong lightweight Lexan<sup>®</sup> polycarbonate shell.
- Replaceable anti-scratch inner visor.
- Fully removable, washable liner.
- Microlock<sup>®</sup> quick-release chin strap.
- Complete with protective storage pouch.
- ECE version not available in North America.

Shell: Lexan Polycarbonate

#### BENEFITS

- Superior quality and great look.
- High-impact resistance and comfort.
- Good visibility and practicality.
- Anti-bacterial, anti-fungal and moisture wicking for added comfort and hygiene.
- Added safety and convenience.

DOT ECE22.05



### CAN-AM N21 DURANGO OPEN FACE HELMET

448481 - DOT  
448482 - ECE  
S, M, L, XL, 2XL, 3XL - Matte Black (93)  
**\$184.99**

### NEW CAN-AM N40-5 GT CROSSOVER HELMET

448569 - DOT  
XS, S, M, L, XL, 2XL - White (01), Magnesium (24), Black (90)  
448570 - ECE  
XS, S, M, L, XL, 2XL - White (01), Black (90)  
**\$259.99**





## CAN-AM N44 EVO CROSSOVER HELMET

### FEATURES

- **N-Com B5 Communication System-ready.**
- Redesigned fully removable, washable Clima-Comfort liner.
- 6-in-1 design, super-strong lightweight, aerodynamically-tuned Lexan polycarbonate shell with integrated spoiler.
- Exclusive Crossover technology.
- Optically-correct UV400 face shield with 3-position vent protects the entire face while offering a large eye port and can be changed in seconds.

- Exclusive Vision Protection System (VPS) feature a scratch-resistant, antifogging, sunshield that raises or lowers in an instant.
- Innovative AirBooster multi-vent airflow system and hot air extractor.
- Velour-padded chinstrap with Microlock2 quick-release retention system and adjustable cheek pads.
- Includes all necessary accessories: pinlock antifog insert, peak, side covers, chin guard plugs and helmet storing pouch.

Shell: Lexan Polycarbonate

### BENEFITS

- Improved performance, stability and excellent high-impact resistance.
- Ultra-convenient accessory addition or replacement, maintenance and customization.
- Added safety, exceptional field of vision, and convenience.
- Protection against sun, glare and condensation.
- Exceptional ventilation for unsurpassed temperature control in hot weather.
- Antibacterial, antifungal and moisture wicking for added comfort and hygiene.
- Safety, comfort and wind noise reduction.

**DOT**

## ONE HELMET, SIX LOOKS

QUICK-CHANGE ACCESSORIES ALLOW YOU TO CUSTOMIZE THE LOOK AND FEATURES FOR EVERY RIDE.



**CAN-AM N44 EVO CROSSOVER HELMET**  
448495 - XS, S, M, L, XL, 2XL, 3XL - Matte Black (93)  
**\$394.99**



## MODULAR HELMET

### CAN-AM N104 ABSOLUTE MODULAR HELMET

#### FEATURES

- **N-Com B5 Communication System-ready.**
- Removable, washable and redesigned monobloc cheek pads with integrated chin straps.
- Eyewear Adaptive system marked with red inserts on comfort padding.
- Super-strong lightweight, aerodynamically-tuned Lexan polycarbonate shell with integrated spoiler.
- Optically-correct UV400 face shield with 3-position vent protects the entire face while offering a large eye port and can be changed in seconds.
- Pivoting chin bar.

- Exclusive Vision Protection System (VPS) feature a scratch-resistant, antifogging, sunshield that raises or lowers in an instant.
- Eyewear compatible.
- Innovative AirBooster multi-vent airflow system and chin bar vents.
- Fully removable, washable Clima-Comfort liner and cheek pads.
- Velour-padded chinstrap with Microlock2 quick-release retention system and dual-action Centromatic® release system and chin curtain.
- Complete with Pinlock antifog insert, wind protector with reflective panel and helmet storing pouch.

Shell: Lexan Polycarbonate

#### BENEFITS

- Improved performance, stability and excellent high-impact resistance.
- Added safety, exceptional field of vision, convenience and versatility.
- Protection against sun, glare and condensation.
- Exceptional ventilation for improved temperature control.
- Antibacterial, antifungal and moisture wicking for added comfort and hygiene.
- Comfort, wind noise reduction and performance.

**DOT**



**CAN-AM N104 ABSOLUTE MODULAR HELMET**  
448496 - XS, S, M, L, XL, 2XL, 3XL  
Black (90), White (01)  
**\$454.99**





## ENHANCE THE EXPERIENCE.

Get your message across around every curve, into any headwind, and in the noisiest traffic with our in-helmet communications systems. A lot happens when convenience, comfort and cutting-edge technology come together to create effortless communication. Whether you're out for an hour or in it for the long haul our systems ride with you, letting you stay in touch in almost any driving condition.

## COMMUNICATION SYSTEMS

USE THIS CHART TO FIND THE COMMUNICATION SYSTEM THAT FITS YOUR NEEDS.

FEATURES	NOLAN N-COM B5 4484240090	SENA 20S 4482070090 (SINGLE PACK) 4482080090 (DUAL PACK)
Bluetooth	4.1	4.1
Intercom Distance	0.3 MI (0.5 KM)	1.2 MI (2 KM)
Universal Intercom*	✓	✓
Intercom Connections*	6-WAY**	8-WAY**
Cell Phone and/or GPS and/or MP3 Player Compatible	✓	✓
Advance Noise Control	✓	✓
FM Radio	✓	✓
Voice Command	✓	✓
Helmet Integration	FULLY INTEGRATED (NOLAN'S HELMETS: N40-5, N44 & N104)	EXTERNAL (UNIVERSAL MOUNTING)

\*Can be connected via Bluetooth to intercom systems of other brands.

\*\*Way means number of person who can talk together.



### NOLAN N-COM B5 COMMUNICATION SYSTEM FOR CAN-AM N40-5, N44 & N104 HELMETS - SINGLE PACK

4484240090  
\$319.99

#### FEATURES

- Designed by Nolan to install easily and to integrate perfectly into Can-Am helmets by Nolan.
- Exclusive N-Com modular communication system delivers freedom, flexibility and impressive expandability.
- Excellent audio quality at any speed with long-ride comfort.
- Enjoy conversations with passengers, other riders, listen to music via your MP3 player, use your smartphone, or operate and interact with your GPS unit - even while the device is charging.
- Fully ECE/ONU 2205 compliant.



### SENA 20S BLUETOOTH COMMUNICATION SYSTEM - SINGLE PACK

4482070090  
\$299.99

#### FEATURES

- Super-versatile, water-resistant multi-function Bluetooth communication, navigation and music system designed for outdoor and vehicle sound environment use.
- Driver-to-passenger and driver-to-driver communication at a range over 1.2 miles (2 km).
- Up to 12-hour talk and 10-day stand-by time on a single charge - permits simultaneous charge & play.
- Complete with integrated microphone, wired microphone, wired boom microphone, speakers, plus mp3, earbud and GPS ports.



### SENA 20S BLUETOOTH COMMUNICATION SYSTEM - DUAL PACK

4482080090  
\$549.99

- 4-way conference, smartphone, intercom-to-phone connection, GPS and mp3 music playback via AVRCP operation, or easy-adjust manual operation with exclusive jog dial.
- Voice-prompt feedback, clear and natural sound quality, individual volume control for each audio source, fully-integrated audio booster delivers optimal sound level - fully firmware-upgradeable.



# FOOTWEAR



## SPYDER RT RIDING BOOTS

- Perfect for rain or cold weather.
- Water-repellent leather.
- Hipora® waterproof, windproof and breathable membrane with 100% polyester lining padded with open cell foam for better comfort.
- 3M Scotchlite reflective detail on back.
- Sole structure offering a good grip under all conditions.
- Molded nylon ankle guard.
- Molded nylon shin guard backed with shock absorbing material.
- Injected thermoplastic polyurethane toe pad for shifting gears.
- Techno GI® thermoplastic toe cap.
- Pre-formed orthopedic vibration-absorbing sole.
- Anti-crush tempered steel shank.
- Anti-twist sole.
- High-tech rubber composite sole.

444208 · 7, 8, 9, 10, 11, 12, 13 · Black (90)  
See p. 39 for European footwear equivalencies.  
**\$179.99**



# PROTECTIVE GUARDS



## RETRO REFLECTIVE ARMBAND

- To wear on bicep over a jacket to be more visible.
  - Velcro attachment.
  - Meets France retro-reflective equipment legislation.
- Polyester, Spandex, Polyurethane  
453674 · One size  
Hi-Vis Yellow (26)  
**\$9.99**

## REMOVABLE BACK PROTECTOR

- High shock absorbing performance.
  - Maximal comfort.
  - Can be inserted in most Can-Am Spyder jacket inside pouches for extra protection.
- Viscoelastic Polyurethane Foam  
447321 · S, L, XL · Black (90)  
**\$24.99**

## REMOVABLE ELBOW, KNEE OR SHOULDER PROTECTORS

- Same protectors for elbow, knee or shoulder.
  - Can be inserted in most Can-Am Spyder riding gear inside pouches for extra protection.
  - Sold in pairs.
- Viscoelastic Polyurethane Foam  
Men's 447313 · One size Black (90) **\$24.99**  
Ladies' 447322 · One size Black (90) **\$24.99**

# BAGS



## NEW CAN-AM SLAYER GEAR BAG BY OGIO®

- Large main compartment with easy access to all gear.
  - Large separated boot pocket.
  - Zippered accessory pocket.
  - Easy grab end handles for transport.
  - Detachable shoulder strap.
  - Heavy-duty reinforced base
  - Dimensions: 32" H x 16" W x 18" D (81 cm x 41 cm x 46 cm)
- 4692940090 · Black  
**\$99.99**

## NEW CAN-AM URBAN BACKPACK BY OGIO

- Airport security friendly protective laptop compartment.
  - Padded iPad/tablet/e-reader pocket.
  - Dual side water bottle/accessory holders.
  - Fully adjustable ergonomic shoulder straps.
  - Front pocket with two padded accessory compartments and slip pocket.
  - Dimensions: 19.5" H x 13.5" W x 9.5" D (50 cm x 34 cm x 24 cm).
- 4692930090 · Black  
**\$84.99**

## SHAD+ BACKPACK E-83

- Semi-rigid exterior.
  - Secure storage in 2 zippered main compartments.
  - Zippered inner pocket with padded compartments.
  - Adjustable waist and chest straps.
  - Cushioned carry handle.
  - Slip pocket.
  - Adjustable to backpack with 4 metal buckles.
- 219400729 · Black  
**\$149.99**





# GLOVES



Hot Weather



All Weather



Cold Weather



## LEATHER GLOVES

- Fine grade leather.
- Fit perfectly to offer warmth and protection for mild weather.
- Suede forefinger to wipe visor.
- Padded palm for comfort during longer rides.

Shell: Cow Leather

**Men's Blake**  
446290 · M, L, XL, 2XL, 3XL · Black (90)

**Ladies' Veronica**  
446291 · S, M, L, XL, 2XL · Black (90)

**\$49.99**

Men's



Ladies'



## MECHANIC GLOVES

- Multizone padded palm reduces hand fatigue from shock and vibration.
- Pre-curved design for improved fit.
- Double Clarino® layer at palm and thumb for extra durability and increased comfort.

Shell: Nylon, Polyester, Polyurethane, Spandex

446267 · S, M, L, XL, 2XL · Black (90)

**\$39.99**



## TECH PLUS GLOVES

- Leather palm with Kevlar® thread stitching.
- Outdry® technology membrane.
- Waterproof and windproof.
- X-STATIC® mesh liner for antibacterial and moisture management.
- PrimaLoft Gold® insulation at top of hand.
- Leather padded knuckles for better protection.
- Shaped and articulated fingers for maximum grip control.
- Adjustable gauntlet to be worn over or under the jacket.

Shell: Nylon, Polyester

Insulation: Polyester, XT2

446269 · XS, S, M, L, XL, 2XL · Black (90)

**\$159.99**



See the features of the Tech Plus Gloves.  
Go to: [canamspyder.com/videos](http://canamspyder.com/videos)



## NEW SUMMER MESH GLOVES

- Made from flexible, well-ventilated air mesh fabric.
- Lightweight and comfortable.
- Convenient hook-and-loop wrist closure.
- Pre-curved design for improved fit.
- Durable Clarino palm.
- Silicone fingertips for slip-free grip.
- Direct-injection logos.

Men's Shell: Nylon, Polyurethane, Spandex, Polyester

Ladies' Shell: Nylon, Polyurethane, Polyester, Neoprene, Lycra

**Men's**  
446296 · S, M, L, XL, 2XL, 3XL · Black (90)

**Ladies'**  
446299 · XS, S, M, L, XL, 2XL · Black (90)

**\$34.99**



Learn more on the all-new Summer Mesh Gloves.  
Go to: [canamspyder.com/videos](http://canamspyder.com/videos)

Men's



Ladies'



## VSS LEATHER GLOVES

- Hipora® waterproof, windproof and breathable insert.
- Reinforced and padded palm.
- Shaped fingers.
- Articulated and padded knuckle-joint system.
- Silicone palm print for better grip.

Shell: Leather

**Men's**  
446204 · S, M, L, XL, 2XL · Magnesium (24), Black (90)

**Ladies'**  
446216 · S, M, L, XL · Black (90)

**\$89.99**

Men's



Magnesium

Black

Ladies'



Black



# SPORTSWEAR



**SAY HELLO  
TO THE NEW YOU.**

You're unique. You always knew that the journey was the destination and it didn't matter who got there first as long as you enjoyed the ride. Confidence, determination and fearlessness have gotten you far, don't stop now.

JESS LONG SLEEVE T-SHIRT 454040  
ORIGINAL T-SHIRT 454034  
CALIBER POLO 454033



COOPER T-SHIRT 454044  
TECHNICAL LONG SLEEVE T-SHIRT 454042



TECHNICAL LONG SLEEVE T-SHIRT 454041





MEN'S SPORTSWEAR

TEES

**NEW COOPER T-SHIRT**

100% Cotton  
454044  
S, M, L, XL, 2XL, 3XL  
Heather Grey (27),  
Blue (80)  
\$24.99



**NEW TECHNICAL LONG SLEEVE T-SHIRT**

· Stretchy technical fabric for extra comfort and ease of movement.  
88% Polyester, 12% Elastane  
454041  
S, M, L, XL, 2XL, 3XL  
Charcoal Grey (07),  
Blue (80)  
\$59.99



**NEW ORIGINAL T-SHIRT**

100% Cotton  
454034  
S, M, L, XL, 2XL, 3XL  
Heather Grey (27),  
Black (90)  
\$24.99



**NEW LONG SLEEVE ORIGINAL T-SHIRT**

100% Cotton  
454036  
S, M, L, XL, 2XL, 3XL  
White (01),  
Black (90)  
\$34.99



**NEW CALIBER POLO**

· Moisture wicking polyester to keep you cool and dry.  
100% Polyester  
454033  
S, M, L, XL, 2XL, 3XL  
Charcoal Grey (07)  
\$49.99



**NEW COOPER LONG SLEEVE T-SHIRT**

100% Cotton  
454039  
S, M, L, XL, 2XL, 3XL  
Blue (80),  
Heather Grey (27)  
\$34.99



CAPS

**NEW CRUISE CAP**

· Adjustable back strap.  
· Embossed logo on front panel.  
100% Cotton  
447316  
One size  
Black (90), Blue (80)  
\$24.99



**NEW CLASSIC CAP**

· Adjustable back strap.  
100% Cotton  
447320  
One size  
Black (90)  
\$19.99



**NEW CALIBER CAP**

· Adjustable back strap.  
100% Cotton  
447315  
One size  
Charcoal Grey (07), Black (90)  
\$24.99



\*Product may differ from picture shown.





LADIES' SPORTSWEAR



## TEES

### NEW LADIES' TECHNICAL LONG SLEEVE T-SHIRT

Stretchy technical fabric for extra comfort and ease of movement.  
88% Polyester, 12% Elastane

454042  
S, M, L, XL, 2XL, 3XL  
Charcoal Grey (07), Wine (32)

\$59.99



### NEW RIDE T-SHIRT

95% Cotton, 5% Elastane  
454043  
S, M, L, XL, 2XL, 3XL  
Wine (32), Black (90)

\$24.99



### NEW JESS LONG SLEEVE T-SHIRT

95% Cotton, 5% Elastane  
454040  
XS, S, M, L, XL, 2XL, 3XL  
Wine (32), Teal (74)

\$34.99



### NEW ORIGINAL T-SHIRT

95% Cotton, 5% Elastane  
454035  
XS, S, M, L, XL, 2XL,  
White (01), Black (90)

\$24.99



### NEW "BLING" T-SHIRT

95% Cotton, 5% Elastane  
454037  
XS, S, M, L, XL, 2XL, 3XL  
White (01), Black (90)

\$24.99





IF WE SELL IT, WE STAND BY IT.

# BRP LIMITED WARRANTY\*

FOR NEW PARTS, ACCESSORIES AND RIDING GEAR.

1 YEAR LIMITED WARRANTY\*\*

 **GENUINE BRP PARTS AND ACCESSORIES**  
installed by you or your authorized BRP dealer

 **AFTERMARKET PRODUCTS SOLD BY BRP**

 **RIDING GEAR**

4 YEAR LIMITED WARRANTY\*\*

 **HELMETS**



GET ALL THE DETAILS FROM YOUR CAN-AM SPYDER DEALER

\* Purchased at an authorized BRP dealership / distributor or on a BRP-authorized online store. Other exclusions may apply, see complete limited warranty or contact your Can-Am Spyder authorized dealer.  
\*\* Unless otherwise stipulated or required by law.  
This limited warranty does not apply to factory installed accessories. This limited warranty does not apply on Evinrude parts and accessories.

## HOW TO MEASURE

For best results, have someone else take measurements. Measure body in underwear. Tape must be snug but not tight. If measurements fall between two sizes, order the larger size.

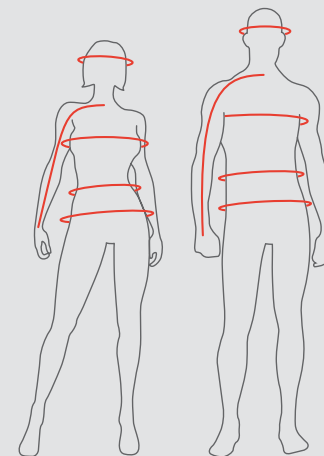

**HEAD**  
Around your head, from the center of the forehead, above the ears and over the natural bump at the back of the head.

**CHEST/BUST**  
Measure under your arms, around the fullest part of your chest.

**WAIST**  
Measure around your natural waistline, keeping one finger between the tape and body.

**HIPS**  
Across the fullest part of the seat.

**ARM LENGTH**  
Let hands down the side in a slightly bent position. Measure from center back neck bone, along shoulder point and elbow, to bottom of wrist bone.

**GLOVES**  
Measure palm width.

## WHAT CODE REPRESENTS YOUR SIZE?

1. Find your size.
2. The corresponding code is THE CODE you use to complete the part number on your order.  
Example: 440227\_\_90  
Size: M = Code 06  
Therefore 440227 06 90

For tall sizes, look for the "T" next to the size. Example: "MT" stands for Medium Tall.

CODE	00	02	04	72	06	09	73	12	14	16	27	28	29	30	31	32	33
SIZE	OS	XS	S	S/M	M	L	L/XL	XL	2XL	3XL	7	8	9	10	11	12	13
		62		63		64		65		66		67		68			
SIZE		M PLUS		L PLUS		XL PLUS		2XL PLUS		3XL PLUS		4XL PLUS		5XL PLUS			

### MEN'S REGULAR · 5'8" - 6'0"

JOSH, MEN'S CRUISE AND RUSSELL MESH JACKETS

	XS	S	M	L	XL	2XL	3XL
Chest (in)	33-35	35-37	37-40	40-44	44-48	48-52	52-56
Waist (in)	27-29	29-31	31-34	34-38	38-42	42-46	46-50
Hips (in)	33-35	35-37	37-40	40-44	44-48	48-52	52-56
Arm length (in)	30	31	32	33	34	35	35

### MEN'S PLUS SIZE · 5'8" - 6'0"

BRUCE PLUS, SHAUN PLUS MESH, COOPER PLUS AND MEN'S CRUISE PLUS JACKETS

	S PLUS	M PLUS	L PLUS	XL PLUS	2XL PLUS	3XL PLUS	4XL PLUS	5XL PLUS
<b>VOYAGER</b>	<b>S</b>	<b>M</b>	<b>L</b>	<b>XL</b>	<b>2XL</b>	<b>3XL</b>		
Chest (in)	38-40	40-43	43-47	47-51	51-55	55-59	59-62	62-66
Waist (in)	35-37	37-40	40-44	44-48	48-52	52-56	56-59	59-68
Hips (in)	38½-40½	40½-43½	43½-47½	47½-51½	51½-55½	55½-59½	59½-62½	62½-71½
Arm length (in)	31	32	33	34	35	35	36	36

### LADIES' REGULAR · 5'4" - 5'8"

HANNA, LADIES' CRUISE AND KATE MESH JACKETS

	XS	S	M	L	XL	2XL	3XL
Chest (in)	32-34	34-36	36-39	39-42	42-45	45-49	49-53
Waist (in)	24-26	26-28	28-30	30-34	34-37	37-41	41-45
Hips (in)	34-36	36-38	38-40	40-44	44-47	47-51	51-55
Arm length (in)	31	31	31½	32	32½	33	34

### LADIES' PLUS SIZE · 5'4" - 5'8"

NICKY PLUS, EMMA PLUS MESH, HANNA PLUS AND LADIES' CRUISE PLUS JACKETS

	M PLUS	L PLUS	XL PLUS	2XL PLUS	3XL PLUS	4XL PLUS
Chest (in)	39-42	42-45	45-48	48-52	52-56	56-60
Waist (in)	32-34	34-38	38-41	41-45	45-49	49-53
Hips (in)	41-43	43-47	47-50	50-54	54-58	58-62
Arm length (in)	31½	32	32½	33	34	34

### REMOVABLE BACK PROTECTORS

	MEN'S JACKET SIZES	LADIES' JACKET SIZES
S	S and M	XS to L
L	L to 2XL	XL to 5XL
XL	3XL to 5XL	-

### MEN'S GLOVES

	XS	S	M	L	XL	2XL	3XL
Inches	3	3¼	3½	4	4½	5	5½

### LADIES' GLOVES

	XS	S	M	L	XL	2XL
Inches	2½	2¾	3	3½	4	4½

### HELMETS

	XS	S	M	L	XL	2XL	3XL
Head circumference (in)	20¾-21¼	21½-22	22¾-23¼	23½-23¾	24-24¾	24¾-25½	25½-25¾

### CAN-AM SPYDER RT RIDING BOOTS

SIZE US	7	8	9	10	11	12	13
SIZE EU	40	41	42	43	44	45	46
Foot length (in)	10.0	10.2	10.5	10.7	11.0	11.3	11.5
Foot length (cm)	25.3	26.0	26.7	27.3	28.0	28.7	29.3



# ACCESSORIES

---



**LOOK BEYOND  
THE ORDINARY.**





## UNIQUE BEGINS WITH U

**Create a Can-Am Spyder that's as unique as you are.  
Our exclusive 4U Guide is the key to kick starting your customization.  
Choose and cruise. As easy as 1-2-3-4.**

We created the 4U Guide, your personal guide to customization. It's based on you - your needs, your riding style, your personality and preferences - so the accessories you choose will be the right ones.

These 4 questions will help you better understand your needs and really make this guide work for you in selecting accessories.

**1. Is your Can-Am Spyder adjusted to your body?**

Run through our U-Fit section and find what handlebar and footpeg positions fit you best.

**2. Does your Can-Am Spyder have all the accessories you need?**

Would you like to reduce the wind flow to your face? Are you riding solo or 2-up? Do you need more storage space? Check out our U-Function section and make your vehicle better suited for you.

**3. Does your Can-Am Spyder truly express your personality?**

Are you looking for a sportier attitude? Or a more luxurious look with chrome accessories? Discover our custom accessories in the U-Style section.

**4. Do you want to unleash the power and handling of your Can-Am Spyder?**

Are you looking for a deeper more guttural sound? A cushier ride? Find what you need in our U-Performance section.

The 4U Guide is the simplest way to create a Can-Am Spyder that's truly a reflection of you. We've thought of everything including compatibility and fit with accessories. The 4U Guide makes choosing accessories simpler, more practical, and easier to understand. Now nothing stops U.



### U-FIT

Now you can tailor your Can-Am Spyder to fit you like a dream. Tweak and adjust the fit that lets you truly connect with your ride. It's all about comfort and enjoying every stretch and curve of the road to freedom.

**UFIT SYSTEM  
HANDLEBARS  
BRAKE & SHIFTER LINKAGES  
FOOTBOARDS**



### U-FUNCTION

Every outing is different and that's part of the fun. Customize your Can-Am Spyder for the way you usually ride, and thanks to our easy-to-add or -remove integrated accessories, you can adjust as you need. Is it a solo or 2-up trip today? Stripped down or fully loaded? It's your journey—do it your way.

**SEATS & BACKRESTS  
WINDSHIELDS & WIND PROTECTION  
CARGO & STORAGE  
LIGHTS & ELECTRICAL ACCESSORIES**



### U-STYLE

Personalization speaks volumes about who you are, and our custom accessories let you say it with added sophistication and style. Don't just embrace your inner self, make a statement.

**WHEELS  
FENDERS  
CUSTOM ACCESSORIES  
DECALS**



### U-PERFORMANCE

Unleash the untapped power and handling of your Can-Am Spyder with our performance-boosting accessories. Because freedom means you get to choose how you travel your road.

**SHOCKS  
SILENCERS**





# SPYDER F3

---

ACCESSORIES

BLUE RIDGE WINDSHIELD 219400746



SIGNATURE LIGHT 219400599



Let our customized versions of these Can-Am Spyder F3 serve as inspiration for creating your own! How would you build yours?

## F3-S SPEEDWAY INSPIRED LOOK

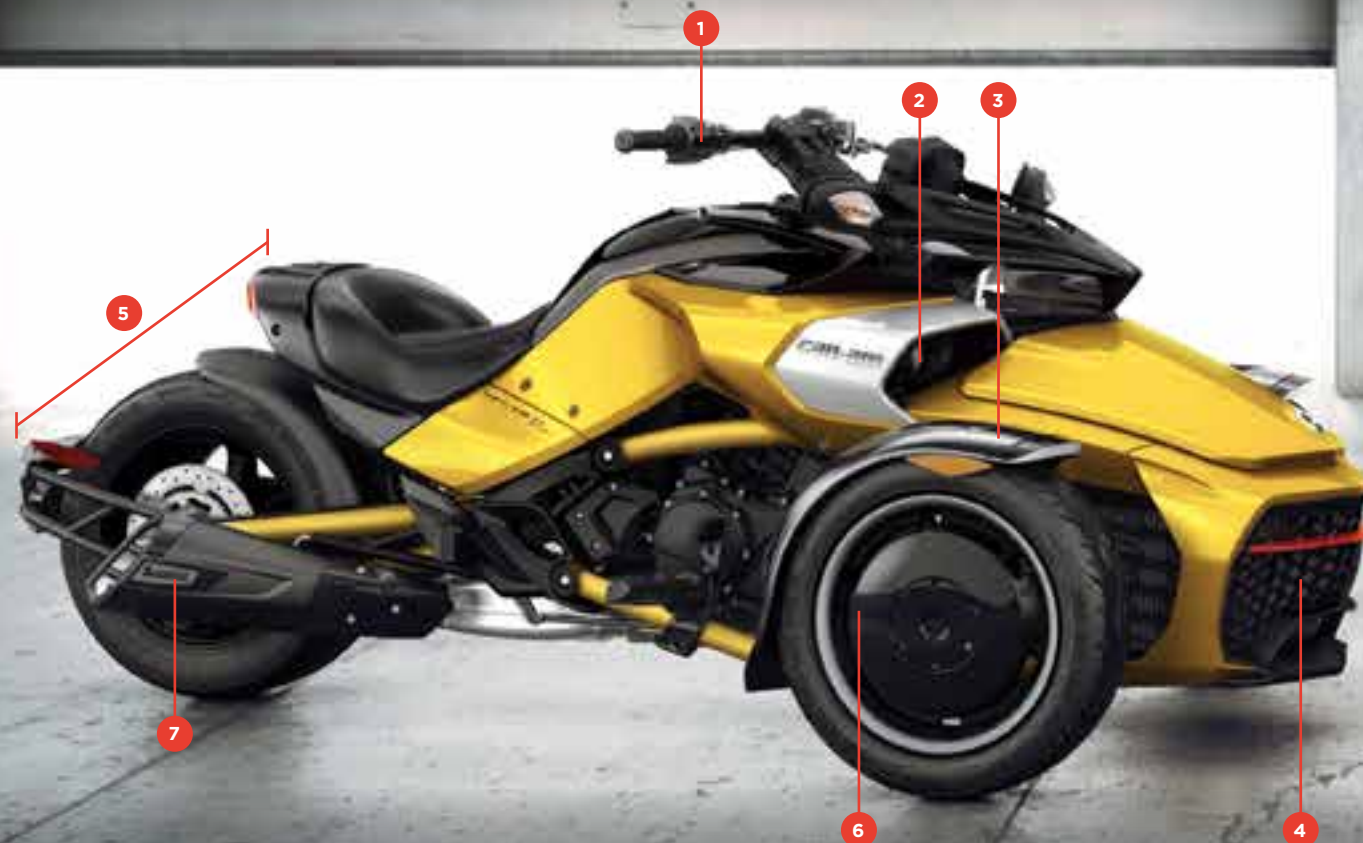

### U-FIT

- 1 DRAG BAR P. 51

### U-FUNCTION

- 2 AUXILIARY LIGHTS P. 63

### U-STYLE

- 3 LOW BROW FRONT FENDERS P. 66  
4 SUPER SPORT GRILLE P. 67  
5 BOBBER KIT P. 67  
6 15" BONNEVILLE DISH WHEELS P. 65

### U-PERFORMANCE

- 7 AKRAPOVIČ<sup>+</sup> SINISTER SILENCER P. 71  
8 FOX<sup>+</sup> ADJUSTABLE REAR SHOCK (NOT VISIBLE ON THE IMAGE ABOVE) P. 69  
9 FOX FACTORY SERIES 1.5 PODIUM R FRONT SHOCKS (NOT VISIBLE ON THE IMAGE ABOVE) P. 70

## F3-S BREAK FREE INSPIRED LOOK



### U-FIT

- 1 DRIVER FOOTBOARDS P. 53  
2 PASSENGER FOOTBOARDS P. 53

### U-FUNCTION

- 3 BLUE RIDGE WINDSHIELD P. 56  
4 AUXILIARY LIGHTS P. 63  
5 ROADTHUNDER<sup>+</sup> SOUNDBAR BY MTX<sup>+</sup> P. 64  
6 VINYL COAST-TO-COAST SEAT P. 54  
7 DETACHABLE DRIVER BACKREST P. 55  
8 DETACHABLE PASSENGER BACKREST P. 55  
9 SHAD SADDLEBAGS FOR CAN-AM P. 59

### U-STYLE

- 10 RT-S FRONT WHEELS P. 85

### U-PERFORMANCE

- 11 OCCASIONAL 2-UP REAR SHOCK (NOT VISIBLE ON THE IMAGE ABOVE) P. 70

You're a click away from a custom Can-Am Spyder. Go to: [www.can-am.brp.com/spyder](http://www.can-am.brp.com/spyder) > Build & Price

You can finance all your accessories with the purchase and financing of your Can-Am Spyder F3. Ask your Can-Am Spyder dealer for all the details.



Looking to personalize your Spyder F3 Limited?  
Here is one of countless possibilities.

## F3 LIMITED WEEKEND ESCAPE INSPIRED LOOK CHROME EDITION



## F3-T URBAN CRUISER INSPIRED LOOK

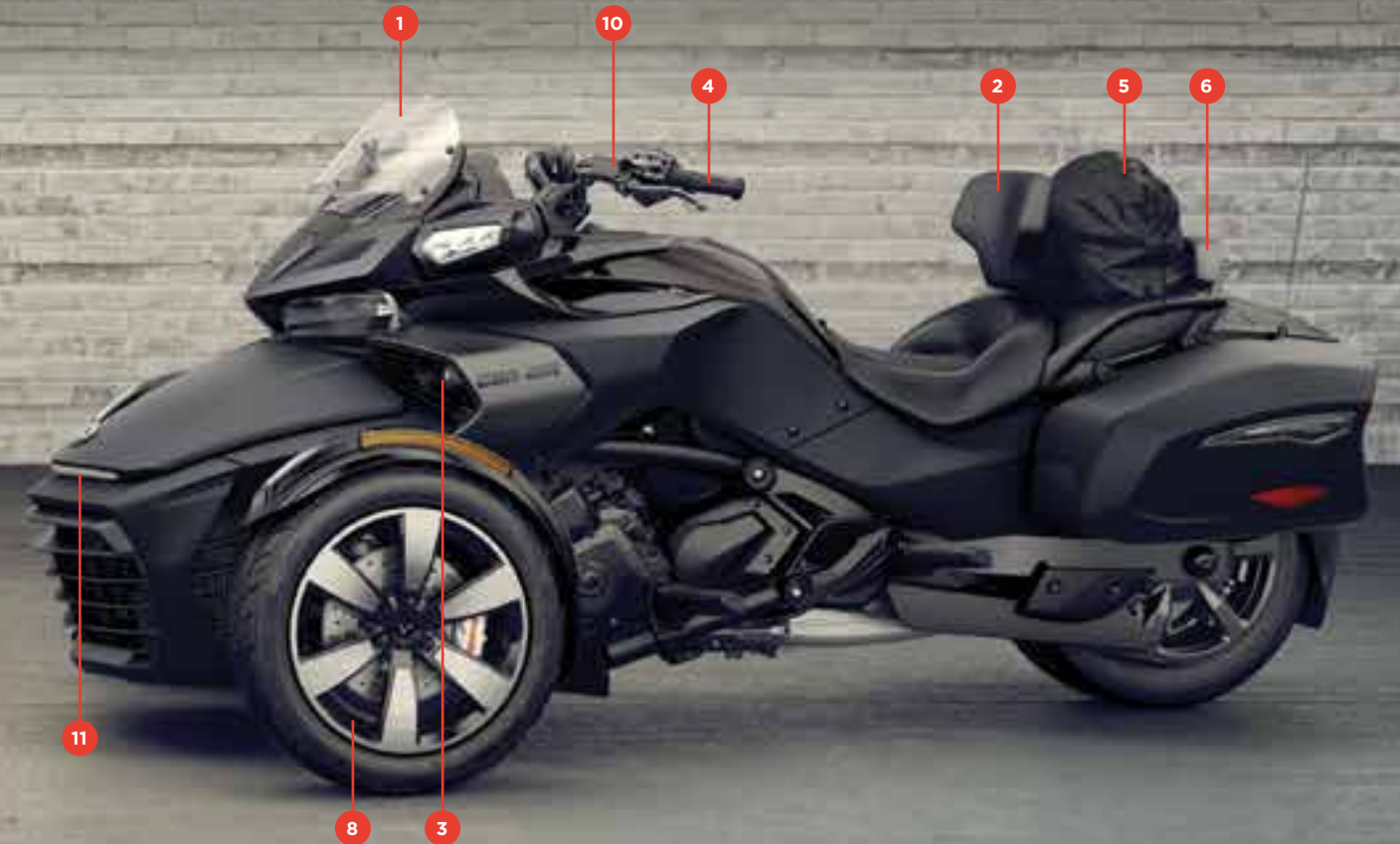

### U-FUNCTION

- |                                       |       |  |       |
|---------------------------------------|-------|--|-------|
| 1 AUXILIARY LIGHTS                    | P. 63 | 7 DELUXE SADDLEBAGS LINERS<br>(NOT VISIBLE ON THE IMAGE ABOVE) | P. 60 |
| 2 TALL BOY WINDSHIELD                 | P. 57 | 8 TOP CASE INNER BAG<br>(NOT VISIBLE ON THE IMAGE ABOVE)       | P. 61 |
| 3 AKRAPOVIČ SPORT TOURING 3C SILENCER | P. 71 |  |       |
| 4 PASSENGER ARMRESTS                  | P. 55 |  |       |
| 5 TOP CASE RACK                       | P. 61 |  |       |
| 6 DETACHABLE DRIVER BACKREST          | P. 55 |  |       |

### TRAILER

- |   |        |
|---|--------|
| 9 TRAILER HITCH<br>(NOT VISIBLE ON THE IMAGE ABOVE) | P. 104 |
|---|--------|

### U-FUNCTION

- |                              |       |   |       |
|------------------------------|-------|---|-------|
| 1 LOW BOY WINDSHIELD         | P. 57 | 7 AUTOMATIC REAR AIR SUSPENSION KIT<br>(NOT VISIBLE ON THE IMAGE ABOVE) | P. 70 |
| 2 DETACHABLE DRIVER BACKREST | P. 55 | 8 DELUXE SADDLEBAGS LINERS<br>(NOT VISIBLE ON THE IMAGE ABOVE)          | P. 60 |
| 3 AUXILIARY LIGHTS           | P. 63 | 9 FRONT CARGO BAG<br>(NOT VISIBLE ON THE IMAGE ABOVE)                   | P. 60 |
| 4 HEATED DRIVER GRIPS        | P. 63 |   |       |
| 5 INTEGRATED HELMET BAG      | P. 62 |   |       |
| 6 PASSENGER SHORT RAIL       | P. 55 |   |       |

### U-FIT

- |                       |       |
|-----------------------|-------|
| 10 ATTITUDE HANDLEBAR | P. 51 |
|-----------------------|-------|

### U-STYLE

- |                    |       |
|--------------------|-------|
| 11 SIGNATURE LIGHT | P. 68 |
|--------------------|-------|

### U-PERFORMANCE

- |  |       |
|--|-------|
| 12 FOX ADJUSTABLE FRONT SHOCKS<br>(NOT VISIBLE ON THE IMAGE ABOVE) | P. 69 |
|--|-------|

You're a click away from a custom Can-Am Spyder. Go to: [www.can-am.brp.com/spyder](http://www.can-am.brp.com/spyder) > Build & Price

You can finance all your accessories with the purchase and financing of your Can-Am Spyder F3. Ask your Can-Am Spyder dealer for all the details.





# YOUR CAN-AM SPYDER. YOUR FIT.

All Spyder F3 models feature our exclusive UFit system so you can customize an exact fit based on your height or preferred riding style. Choose from five footpeg positions and five handlebar options to optimize your fit and comfort.

Find your perfect Spyder fit at [UFITSYSTEM.COM](http://UFITSYSTEM.COM) or visit your dealer to test drive and ask about the showroom fit tool.

## CHOOSE FROM 5 HANDLEBAR OPTIONS

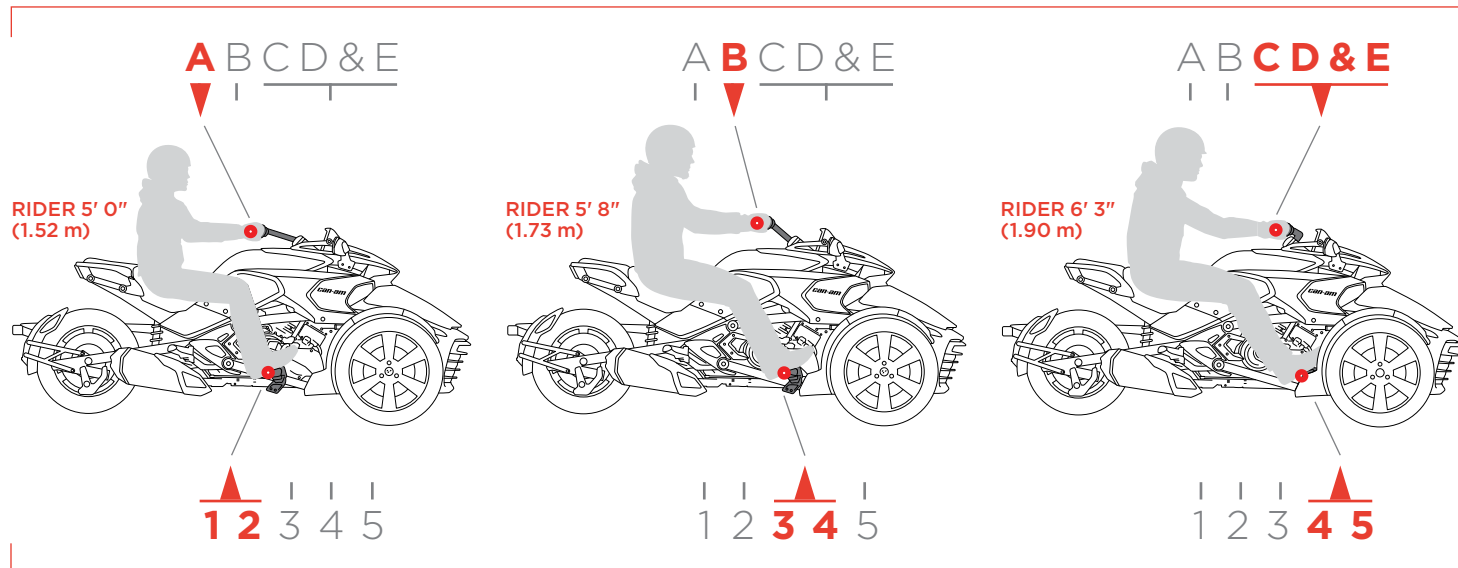

## CHOOSE FROM 5 FOOTPEG POSITIONS



### SHORT REACH HANDLEBAR · POSITION A

- Part of the UFit System.
- Perfect for shorter riders with pegs positions 1 or 2.

All Spyder F3 models

■ 219400545 · Chrome  
(Clamp Kit included)

\$449.99

■ 219400546 · Carbon Black  
\$149.99



### STOCK HANDLEBAR · POSITION B

- Part of the UFit System.
- Same shape and reach as the stock handlebar with a chrome finish.
- Fits best with pegs positions 3 or 4.

All Spyder F3 models

■ 219400547 · Chrome  
(Clamp Kit included)

\$449.99



### LONG REACH HANDLEBAR · POSITION C

- Part of the UFit System.
- The longer reach causes the torso to lean forward, bringing the riding position closer to the console.
- Perfect for taller riders with pegs positions 4 or 5.

All Spyder F3 models

■ 219400548 · Chrome  
(Clamp Kit included)

\$449.99

■ 219400549 · Carbon Black  
\$149.99



### ATTITUDE HANDLEBAR · POSITION D

- Part of the UFit System.
- The shape has an impact on the driving position, leaning the torso towards the console and tilting the arm and wrist position.
- Perfect for taller riders with pegs positions 4 or 5.

All Spyder F3 models

■ 219400550 · Chrome  
(Clamp Kit included)

\$449.99

■ 219400551 · Carbon Black  
\$149.99



### DRAG BAR · POSITION E

- Part of the UFit System.
- Race-inspired straight bar is wide and more forward for a more aggressive riding position or tall drivers.
- Perfect for taller riders with pegs position 5.

All Spyder F3 models

■ 219400646 · Chrome  
(Clamp Kit included)

\$499.99

■ 219400594 · Carbon Black  
\$299.99







**BRAKE & SHIFTER LINKAGES**



**BRAKE & SHIFTER LINKAGES**

- Part of the UFit System.
- Find the best driving position for you.
- Replace stock linkage to set pegs to different positions.

**All F3 SE6 models**

- 2 · Position 1 · 219400561
- 1 · Position 2 · 219400563
- +1 · Position 4 · 219400566
- +2 · Position 5 · 219400571

**\$29.99**

**All F3 SM6 models**

- 2 · Position 1 · 219400560
- 1 · Position 2 · 219400562
- +1 · Position 4 · 219400564
- +2 · Position 5 · 219400565

**\$49.99**



**FOOTBOARDS**



**DRIVER FOOTBOARDS**

- Replace stock pegs for additional comfort.
- Come with rubber pads and mounting hardware.
- Can be positioned with the UFit System.

**All Spyder F3 models**

■ 219400572 · Chrome

**\$549.99**

■ 219400529 · Carbon Black

**\$449.99**



**PASSENGER FOOTBOARDS**

- Replace stock pegs for additional comfort.
- Come with rubber pads and mounting hardware.

**All Spyder F3 models**

■ 219400716 · Chrome

**\$399.99**

■ 219400715 · Carbon Black

**\$299.99**

**IDLER PULLEY**

**F3 IDLER PULLEY SERVICE KIT**

(Not illustrated)

- Enhances your comfort on the road by reducing vibrations generated by the belt.

**All Spyder F3 models**

219800431

**\$34.99**





## U-FUNCTION

### SEATS & BACKRESTS



#### LEATHER COAST-TO-COAST SEAT

- Genuine stitched-leather\* seat.
- Passenger and driver seats rain cover included.
- Installs in seconds and works with both driver and passenger backrests.
- Long-distance comfort based on our renowned coast-to-coast seat design.
- Wide, well-shaped and generously padded driver and passenger seats deliver enough comfort for a coast-to-coast ride.

\* Natural leather fades and wrinkles over time. Allow to air-dry when wet, apply leather-conditioning oil to maintain appearance. Clean with warm water, mild soap and a soft cloth. Use the included seat cover to keep your seat looking new longer.

All Spyder F3 models

■ 219400656 - Tan

**\$899.99**



#### VINYL COAST-TO-COAST SEAT

- Long-distance comfort based on our renowned coast-to-coast design.
- Wide, well-shaped and generously padded driver and passenger seats deliver enough comfort for a coast-to-coast ride.
- Installs in seconds and works with both driver and passenger backrests.

All Spyder F3 models

■ 219400602 - Black

**\$799.99**



#### PASSENGER ARMRESTS

- Adjust upwards, downwards, forwards, backwards, and outwards.
- Arm height provides up to 20 mm vertical adjustment.
- Fully-compatible with RAM® cup holder.
- Complete with grip for added passenger security.
- Top Case not required for installation or use.
- Recommended to install with Top Case (219400732) or Passenger Backrest (219400601 or 219400703).

All Spyder F3 models

■ 219400726 - Black

**\$449.99**



#### ADJUSTABLE PASSENGER BACKREST

- Dual axis adjustments for the backrest and cushion enable you to dial-in comfort and add up to 2" (50 mm) more passenger room.

Spyder F3, F3-S, F3-T

■ 219400601 - Carbon Black

**\$749.99**



#### DETACHABLE DRIVER BACKREST

- Generous width and height for superior lumbar support.
- Installs and removes in minutes.
- Tilt adjustable.
- Fits on production, Cannonball, Vinyl Coast-to-Coast and Leather Coast-to-Coast seats.
- Anti-theft feature.

All Spyder F3 models

■ 219400498 - Black

**\$459.99**



#### CANNONBALL SEAT

- 2-piece driver and passenger seats.
- Installs in minutes.
- Designed with additional padding, larger support areas and integrated comfort rear pad.
- Distinctive high-end stitching pattern.
- Driver backrest ready.

All Spyder F3 models

■ 219400497 - Black

**\$819.99**



#### DETACHABLE PASSENGER BACKREST

- Generous width and height for superior lumbar support.
- Initial installation in minutes, toolless removal in seconds.
- Anti-theft feature.
- Fits on production, Cannonball, Vinyl Coast-to-Coast and Leather Coast-to-Coast seats.
- Invisible mounting system unrecognizable when not installed.

Spyder F3, F3-S, F3-T

■ 219400703 - Black

**\$559.99**



#### PASSENGER SHORT RAIL

- Sporty looking short passenger comfort rear pad.
- Installs in minutes.
- Fits on production, Vinyl Coast-to-Coast and Leather Coast-to-Coast seats.

Spyder F3, F3-S, F3-T

■ 219400580 - Black

**\$359.99**





**WINDSHIELDS & WIND PROTECTION**



✓  
Can-Am Spyder accessories are subject to the same rigorous physical testing requirements as the vehicles.



**GAUGE SPOILER**

- Enhances the sporty look of the Can-Am Spyder F3.
- Made of injected tinted polycarbonate.

Spyder F3, F3-S

■ 219400531 · Smoke

**\$169.99**

**WINDSHIELD TRIM KIT**

- Dresses up accessory windshield kits with chrome center trim.
- Looks great with Windshield Trims (219400355).

Fits with Tall Boy Windshield (219400596) and Low Boy Windshield (219400504)

■ 219400698 · Chrome

**\$29.99**



**BLUE RIDGE WINDSHIELD**

- Made of clear 4.5 mm polycarbonate.
- Comes complete with supports and hardware.

Spyder F3, F3-S

□ 219400746 · Clear

**\$409.99**

**ROUTE 129 WINDSHIELD**

- Sport windshield.
- Made of 4.5 mm polycarbonate.
- Provides lower body protection.
- Comes complete with supports and hardware.

Spyder F3, F3-S

□ 219400747 · Clear

**\$359.99**

**TALL BOY WINDSHIELD**

- Mid-height windshield.
- Scratch and UV-resistant hardcoat on 5 mm polycarbonate shield.
- Windshield supports included.

Spyder F3-T, F3 Limited

□ 219400596 · Clear

**\$399.99**

**LOW BOY WINDSHIELD**

- Sporty low windshield.
- Scratch and UV-resistant 4.5 mm polycarbonate shield mounts on the stock supports.

Spyder F3-T, F3 Limited

■ 219400504 · Smoke

**\$199.99**





**SHAD**  
FOR *can-am*

BRP partners with SHAD, a recognized leader in the manufacture of high-advanced motorsport bags and storage accessories.

Their designs are known to be the state-of-the-art, totally functional and of first class quality, which have earned them the prestigious international "Red Dot: Best of the Best" award in 2015.

## CARGO & STORAGE



### SHAD SADDLEBAGS FOR CAN-AM

- Patented lightweight bike-specific design.
- 3-point mount.
- Waterproof, shock resistant.
- 9.5 US gallons capacity (36 L).
- Enough room for a 2XL full face helmet equipped with a communication system.
- Unique Can-Am reflector.
- Required mounting support and hardware are sold separately (219400728).
- Required mounting support for Europe (219400727).

**Spyder F3, F3-S**

■ 219400721 - Black

**\$469.99**

### SHAD SADDLEBAGS F3 RACK

(Not illustrated)

- Custom rack specially designed for mounting SHAD Saddlebags (219400721).
- Integrated red reflectors and necessary hardware for SHAD Saddlebags.

**Spyder F3, F3-S**

■ 219400728 - Black

■ 219400727 - Black - Europe (Amber reflectors) EC compliant

**\$249.99**



### SHAD SADDLEBAGS LINERS

- Designed expressly for SHAD Saddlebags (219400721) to provide extra convenience.
- Include integrated carrying handle and a shoulder strap.
- Sold in pairs.

**Spyder F3, F3-S**

■ 219400731 - Black

**\$94.99**



### SHAD REAR SEAT BAG

- 100% waterproof 3-layer (PVC-Nylon-PVC) design that's tear and abrasion resistant.
- 7.4 US gallons capacity (28 L).
- Foam-lined inner compartment for laptop or other valuables.
- Includes attachment straps.
- Converts to backpack, complete with chest strap.

**All Spyder models**

■ 219400730 - Black

**\$129.99**



### SHAD BACKPACK E-83

- Semi-rigid exterior.
- Secure storage in 2 zippered main compartments.
- Zippered inner pocket with padded compartments.
- Adjustable waist and chest straps.
- Cushioned carry handle.
- Includes cover for any helmet size that can be fixed to the backpack with 4 metal buckles.

■ 219400729 - Black

**\$149.99**





**CROSS-COUNTRY DETACHABLE SADDLEBAGS**

- Add a total of 13 US gallons (50 L) of storage space.
- Finished in high-end vinyl and with a metal chrome side hinge.
- Water-resistant and top loading, lockable with key.
- Toolless installation and removable in seconds after initial installation.
- Brackets are invisible when bags are not on.
- Bolts 250000869 needed to install 2015 Cross-Country Detachable Saddlebags (219400492 and 219400590 (EC)) on 2016 models.

**Spyder F3, F3-S**  
 ■ 219400696 - Black  
 ■ 219400697 - Black - Europe (Amber light) - EC compliant  
**\$1,330.99**



**DELUXE SADDLEBAGS LINERS**

- Complete your production saddlebags with Deluxe Saddlebags liners.
- The easiest way to carry your items from your Can-Am Spyder saddlebags, with integrated handle.

**Spyder F3-T, F3 Limited**  
 ■ 219400606 - Black  
**\$99.99**



**CROSS-COUNTRY SADDLEBAGS LINERS**

- Soft travel bags for use inside the Cross-Country Detachable Saddlebags (219400696, 219400697 EC).
- Integrated handle for easy transport.
- Sold in pairs.

**Spyder F3, F3-S**  
 ■ 219400609 - Black  
**\$69.99**



**FRONT CARGO BAG**

- Easy way to organize and tote your items in the front cargo compartment.
- Slides in and out with integrated handle and shoulder strap.

**All Spyder F3 models**  
 ■ 219400631 - Black  
**\$89.99**

**LOCK KIT FOR CROSS-COUNTRY DETACHABLE SADDLEBAGS**

- (Not illustrated)
- Replacement lock and key for Cross-Country Detachable Saddlebags (219400696, 219400697 EC)

**Spyder F3, F3-S (service kit)**  
 219400737  
**\$94.99**



**TOP CASE WITH INTEGRATED PASSENGER BACKREST**

- Fits up to two 2XL full face helmets including communication system.
- Integrated passenger backrest.
- Protective rubber carpet-lined bottom.
- Quick installation and removal.
- Required vehicle color matching side panels to complete the top case assembly - sold separately.

**Spyder F3-T 2018 and prior**  
 ■ 219400897 - Black  
 ■ 219400898 - Black - Europe - EC certified

- Top Case Speakers Amplifier Kit (219400769) is required to play music through top case speakers.

**Spyder F3-T 2016-2017, F3 Limited 2016**  
 ■ 219400732 - Black  
 ■ 219400772 - Black - Europe - EC certified

**\$1,624.99**



**TOP CASE PANEL KIT**

- Vehicle-matched top case side panels.

**Spyder F3-T with Top Case**  
 ■ 219400758 - Steel Black Metallic  
 ■ 219400759 - Pearl White  
 ■ 219400760 - Intense Pearl Red  
 ■ 219400761 - Pure Magnesium  
 ■ 219400859 - Oxford Blue Metallic  
**\$214.99**  
**\$199.99**



**TOP CASE INNER BAG**

- Maximizes top case volume.
- Complete with integrated handle and shoulder strap for convenient portability.

**Spyder F3-T with Top Case, F3 Limited 2017 & up**  
 ■ 219400748 - Black  
**\$129.99**



**TOP CASE SPEAKERS AMPLIFIER KIT**

- (Not illustrated)
- Amplifier kit is required\* to play music through top case speakers.
- Connects to the standard front audio system.
- Includes amp harness and hardware.
- Top Case with Integrated Passenger Backrest (219400732, 219400772 EC) is required.

**Spyder F3-T 2016-2017 with Top Case**  
 219400769  
**\$324.99**



**TOP CASE RACK**

- Allows for added external storage capacity when used with netting or bungee cords.
- Sturdy stamped-aluminum construction.
- Includes integrated anchor points.

**Spyder F3-T with Top Case, F3 Limited 2017 & up**  
 ■ 219400743 - Black  
**\$214.99**





**REAR TAIL RACK**

- Robust monobloc cast-aluminum construction.
- Ideal for stowing soft bags, tents, or sleeping bags.
- Includes convenient integrated anchor points.
- Bolts securely to the vehicle frame.

**Spyder F3-T, F3 Limited 2016**

■ 219400645 - Black

**\$199.99**



**F3 MONO SEAT COWL**

- High quality injection-molded part.
- Pops into passenger seat space in seconds.
- Transforms your vehicle into sporty solo configuration.
- Adds 1.25 US gallons (4.73 L) of lockable water-resistant storage.

**Spyder F3, F3-S**

■ 219400494 - Steel Black Metallic

**\$359.99**



**LIGHTS & ELECTRICAL ACCESSORIES**



**NEW INTEGRATED HELMET BAG**

- Truly integrated easy-to-use helmet storage solution.
- Sturdy water-resistant construction.
- Includes elastic straps for tying down helmet bag onto seat.
- Complete with anti-theft wire for added security.

**All Spyder RT & F3 models**

■ 219400850 - Black

**\$59.99**



**URBAN RACK**

- Solid aluminum construction offering 0.9 US gallon (3.37 L) of water-resistant storage.
- Comes with net to allow users to strap additional luggage on top.
- Pops into passenger seat space in seconds.
- Anti-theft feature.

**Spyder F3, F3-S**

■ 219400493 - Carbon Black

**\$409.99**



**AUXILIARY LIGHTS**

- Halogen fog lamps.
- Enhance low beam light for better visibility.
- Plug-and-play with stock harness.

**All Spyder F3 models**

219400511

**\$509.99**

- Integrated ON/OFF switch.
- Not EC compliant.
- Not compatible with European vehicles.



**HEATED DRIVER GRIPS**

- Complete heating kit with one intensity setting.
- Easy installation.
- Integrated ON/OFF switch.

**Spyder F3, F3-S, F3-T**

■ 219400509 - Black

**\$219.99**



**NEW ROADTHUNDER SOUNDBAR BY MTX**

- Bluetooth speaker with the unbeatable convenience of fingertip control.
  - Rugged IP66-rated weather-resistant speaker designed for outdoor use.
  - Driven by 150 watts of quality audio power.
  - Seamless integration and operation from Bluetooth enabled devices.
  - Includes: input, ground and ignition wires, plus auxiliary port and 3.5" connector cable.
- Note: We recommend you to use 320 Kbps MP3 - 192-256 Kbps AAC or AIFF, WAV formats to match the potential of the speaker. More compressed formats will probably have degraded sound quality.

**Spyder F3, F3-S**

219400840

**\$399.99****NEW CGX3 CAMERA**

- 160° wide angle lens.
- Resolution options: from 3MP up to 20MP and VGA.
- Video resolutions available: 2.7K at 30 frames per second (FPS), 720P at 120/60/30 FPS, 1080P at 60/30 FPS and VGA at 240 FPS.
- Record videos in 4K UHD at 24 FPS, 2.7K QHD at 30 FPS and 720P at 120 FPS.
- Memory: Class 10 32GB micro SD card.
- 2" capacitive touchscreen.
- Li-ion battery capacity of 1050mAh, working time of 1/1.5 hours and charging time of 3 hours (2 batteries included).
- WiFi function remotely operates up to 49.2' (15 m) with mobile devices and CYCLOPS app for Android and IOS.
- Waterproof up to 32.8' (10 m) without a case.
- Features modes such as invert, time lapse, high speed & loop recording, motion detection, capture (while recording a video), burst and anti-sharing.
- Comes with 8 mounting accessories.



9700130090

**\$349.99****CYCLOPS 360° PANORAMIC HD VIDEO CAMERA**

- Features a 220-degree wide-angle lens.
- Video resolutions up to 4K at 30 frames per second.
- Professional 16MP quality photos.
- Rugged, light and portable.
- Magnetic mount for vibration-free footage and mounting to any metal surface.
- Comes with 32GB Class 10 micro SD card.
- Waterproof case up to 164' (50 m).
- Wi-Fi available to remotely control your camera from your smartphone or computer with the free CGX2 App.
- 16 modes and effects, including driving mode, loop recording, time lapse and slow motion.
- Comes with 10 mounting accessories.
- Compatible with VR goggles.



9700020090

**\$349.99****GPS HOLDER (WITHOUT HARNESS)**

(Not illustrated)

**All Spyder F3 models**

219400717

**\$189.99****GARMIN ZUMO GPS HOLDER (WITHOUT HARNESS)**

(Not illustrated)

**All Spyder F3 models**

219400718

**\$174.99****BOLTS KIT FOR GPS HOLDER**

(Not illustrated)

· Required to fit Garmin Zumo GPS Holder (219400718) on Drag Bars (219400646, 219400594).

**All Spyder F3 models**

219400655

**\$19.99****GPS HOLDER**

- Sits high on right side handlebar for optimum visibility.
- Multidirectional adjustment to prevent sun glare and adapts to any rider.
- Harness included.

**All Spyder F3 models**

219400749

**\$219.99****GARMIN ZUMO 590 GPS**

- Features a glove-friendly and sunlight-readable 5" (12.7 cm) dual-orientation touchscreen display.
- Offers hands-free phone control and spoken directions heard in-helmet via Bluetooth® 5 technology.
- Includes a MP3 player.
- iPod® and Pandora® compatibility.
- Allows control of music right on the display.

**All Spyder models**

219400512

219400699 · Europe

**\$799.99**

Zumo 590 has the ability to link itself wirelessly to optional Garmin tire pressure sensors and the Garmin Virb video camera for enhanced GPS functionality.

- Rugged and tough enough to withstand fuel spills, UV rays and harsh weather.
- Offers access to real-time weather and traffic information via the smartphone link app.
- Free lifetime map updates.
- Curvy Roads Routing allows rider to find winding roads.
- GPS Holder (219400681) sold separately.

**POWER OUTLET KIT**

- Recharges your electronic devices while riding\* (smartphone, MP3, heating gear, etc.).
- Dual port USB connectors.
- Plug-and-play kit.
- Simply connect under driver seat and use.

\*The power outlet is not capable of recharging all device types while riding.

**All Spyder RT models, RS, ST, F3, F3-S**

219400510 · USB

- Adds an extra 12V power outlet to your vehicle.
- Conveniently located in front cargo bin.

**All Spyder models**

219400366 · 12V

**\$34.99****GARMIN ZUMO GPS HOLDER**

- Positions Garmin Zumo GPS on the center of all UFit System handlebars.
- Wiring/charging harness included.

**All Spyder F3 models**

219400681

**\$249.99****F3-T FRONT RADIO SYSTEM**

- Upgrades sound, 2 woofers speakers and 2 mids (4X20 watts), USB plugs, aerial and hardware included.

**Spyder F3-T, F3 Limited 2016**

219400680

**\$929.99**

**U-STYLE**
**WHEELS****15" SHAMROCK WHEELS**

- Add personality to your Can-Am Spyder.
- Casted, painted and machined wheels.
- Sold in pairs.

**All Spyder F3 and RT models, RS, ST 2013 and up**
 219400500 · Deep Black
**\$609.99****15" FAT 6 CHROME WHEELS**

- Same design as Spyder F3 production wheels in PVD finish.
- Sold in pairs.

**All Spyder F3 and RT models, RS, ST 2013 and up**
 219400589 · Chrome
**\$719.99****CHROME REAR WHEEL**

- 6-spoke PVD – chrome-like powder-coat, more resistant than regular chrome – monobloc rear wheel (hub and wheel in one piece).

**All Spyder F3 and RT models, RS, ST 2013 and up**
 219400574 · Chrome
**\$659.99****15" BONNEVILLE DISH WHEELS**

- Give your Can-Am Spyder a retro look with these 15" wheels inspired by Salt Flat racers.
- Wheel nuts are hidden behind the center cap.
- Sold in pairs.

**All Spyder F3 and RT models, RS, ST 2013 and up**
 219400501 · Black
**\$599.99****15" BLADE MAG WHEELS**

- Unidirectional design (left and right wheel).
- Patented casting process allows a weight reduction of 2.2 lbs (1 kg) per wheel compared to stock wheels.
- Sold in pairs.

**All Spyder F3 and RT models, RS, ST 2013 and up**
 219400465 · Black
**\$659.99****15" BLADE MAG WHEELS SERVICE KIT**



(Not illustrated)

- Replacement "blade" for wheels.

 219400542 · Left · Brushed Aluminum

 219400543 · Right · Brushed Aluminum
**\$24.99****15" RT FRONT WHEELS**

- 15" 12-spoke mags.
- Sold in pairs.

**All Spyder F3 and RT models, RS, ST 2013 and up**
 219400365 · Grey
**\$579.99**
 219400419 · Carbon Black
**\$599.99**





## CUSTOM ACCESSORIES



A bobber, originally called a 'bob-job' from the 1930s through 1990s, is a style of custom motorcycle. The typical construction includes stripping excess bodywork from a motorcycle, and shortening the rear fender, which is "bobbed" (as in bob-tail).



### BOBBER KIT\*

- Everything needed to transform a 2-up into a 1-up.
- Rear fender, tail light assembly, footrest trim, license plate support, and all necessary hardware included.
- Can also accommodate any production or accessory seat.

\* · A bobbed tail increases the amount of projection from the rear tire versus a traditional fender.

· Laws vary state to state regarding rear fender tire coverage compliance. Please obey all applicable laws and regulations.

**Spyder F3, F3-S**

■ 219400640 · Black

■ 219400745 · Black · Europe · EC compliant

(Doesn't include rear fender and licence plate support)

**\$799.99**

### SUPER SPORT GRILLE

- Adds an even more muscular look with this honeycomb-styled front grille with integrated front splitter.

**All Spyder F3 models**

■ 219400595 · Black / Can-Am Red

**\$349.99**

## FENDERS

### CHOPPED REAR FENDER

- Sleek, short fender shows off the massive Spyder F3 rear tire.
- Street legal and includes license plate holder, LED light and required hardware.
- License plate holder not compliant outside North America.

**Spyder F3, F3-S**

■ 219400597 · Carbon Black

**\$429.99**



### LOW BROW FRONT FENDERS

- Super sleek drawn steel fenders with LED position lights integrated into the front edge.
- Include electrical harness and required hardware.
- Sold in pairs.
- LED position lights not EC compliant.

**All Spyder RT models .RS, ST 2013 and up, all Spyder F3 models**

■ 219400502 · Carbon Black

**\$949.99**



### PULLEY COVER

- Replaces the stock plastic PTO (drive pulley) cover with a genuine chrome cover.

**All Spyder F3 models**

■ 219400557 · Chrome

**\$199.99**



### TMC COVER

- Replaces the stock plastic TMC (master cylinder) cover with a genuine chrome cover.

**All Spyder F3 models**

■ 219400559 · Chrome

**\$209.99**







**SIGNATURE LIGHT**

- Creates an unmistakable, distinctive look.
- No switch, automatically turns on.
- Includes required wiring and hardware for Spyder F3 2016 models and up.
- Not EC compliant.

All Spyder F3 models

219400599 - White

\$169.99

**SIGNATURE LIGHT - 2015 ADAPTER KIT**

- (Not illustrated)
- Wiring harness required for installing Signature Light (219400599) on 2015 models.
  - Allows the light to automatically illuminate when the engine is running.
  - LED lights.

Spyder F3, F3-S 2015

219400636 - Black

\$39.99



**HANDLEBAR END CAPS**

- Sold in pairs.
- All Spyder models
- 219400702 - Chrome
- \$41.99



**FRAME CAPS**

- Add a little bling to the frame of your vehicle.
  - 4 frame caps per pack.
- All Spyder F3 models
- 219400555 - Chrome
- \$129.99



**DECALS**



**HOOD STRIPES DECAL KIT**

- Adds personality to your Can-Am Spyder F3.
- All Spyder F3 models
- 219400711 - Can-Am Red
  - 219400714 - Gloss White
  - 219400713 - Matte Black
  - 219400712 - Satin Silver
- \$79.99



**F3 MONO SEAT COWL STRIPES DECAL KIT**

- Premium decals complement Hood Stripes Decal Kit.
- Spyder F3, F3-S
- 219400661 - Can-Am Red
  - 219400662 - Gloss White
  - 219400663 - Matte Black
  - 219400664 - Satin Silver
- \$59.99



**REAR TAIL STRIPES DECAL KIT**

- Premium decals complement Hood Stripes Decal Kit.
- Spyder F3-T, F3 Limited 2016
- 219400665 - Can-Am Red
  - 219400666 - Gloss White
  - 219400667 - Matte Black
  - 219400668 - Satin Silver
- \$49.99



**U-PERFORMANCE**

**SHOCKS**



**FOX ADJUSTABLE FRONT SHOCKS**

- Features spring-adjustable preload and wide-range externally-adjustable rebound damping for an infinite array of tuning options made to suit any riding style.
  - Whether it's smooth cruising or twisting down your favorite winding road they deliver exceptional performance, comfort, and a superior quality ride.
- Spyder F3-T, F3 Limited
- 219400733
- \$849.99



**FOX ADJUSTABLE REAR SHOCK**

- FOX Factory Series rear shock delivers an infinite range of set-up options.
  - Anodized lightweight 6061-T6 aluminum body provides enhanced reliability and excellent performance.
- Spyder F3, F3-S
- 219400734
- \$649.99





FOX shocks have been an industry leader in high-performance shocks and racing suspensions for over 30 years.

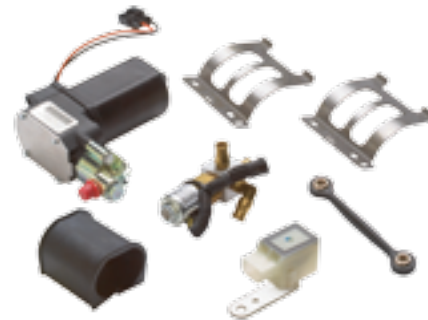

**AUTOMATIC REAR AIR SUSPENSION KIT**

- Automatic suspension assures a smooth, comfortable ride.
- Includes air compressor and all required hardware.

**Spyder F3-T, F3 Limited**  
219400738

**\$464.99**

**FOX FACTORY SERIES 1.5 PODIUM R FRONT SHOCKS**

- Featuring spring-adjustable preload and a wide range of externally adjustable rebound damping, the PODIUM R shocks provide an infinite array of tuning options to comfortably suit your riding style.
- Whether you're out for a mellow cruise or enjoying your favorite twisty route, the PODIUM R shocks will deliver superb performance, great comfort, and an overall quality ride.

**Spyder F3, F3-S**  
219400515  
**\$849.99**



**FOX FACTORY SERIES 2.0 PODIUM RC2 REAR SHOCK**

- Provides an infinite range of options for the perfect set-up.
- Its anodized 6061-T6 aluminum body and remote aluminum reservoir make the lightweight PODIUM RC2 shock a reliable and awesome performer.

**Spyder F3, F3-S**  
219400577  
**\$969.99**



**OCCASIONAL 2-UP REAR SHOCK**

- Weight-bearing capacity designed for occasional 2-up use.

**Spyder F3, F3-S**  
219400739  
**\$199.99**

**SILENCERS**



Akrapovič was established in 1990 by Slovenian racer Igor Akrapovič who had found that during his racing career there was a distinct lack of high-quality exhaust systems on the market to the public.



**AKRAPOVIČ SINISTER SILENCER**

- 3-outlet design exclusive to Can-Am.
- Finished in bold flat black carbon & stainless steel.
- Unique Akrapovič growl.
- Akrapovič Sinister Silencer Heat Shield Replacement Kit available (219400766).
- Not AS certified.

**Spyder F3, F3-S**  
219400701 · Black  
**\$1,099.99**



**AKRAPOVIČ STRAIGHT SHOT SILENCER**

- Premium chromed stainless steel shell construction, end cap and heat shields.
- Not AS certified.

**Spyder F3, F3-S**  
219400514 · Chrome  
**\$1,119.99**



**AKRAPOVIČ SPORT TOURING 3C SILENCER**

- Set your ride apart with the dynamic, deep resonant sound of an Akrapovič silencer.
- Its premium titanium and carbon fiber construction is 55% lighter than stock model and it's been tested to meet the most stringent requirements.
- Not AS certified.

**Spyder F3-T, F3 Limited, RT 2015 and up**  
219400650 · Titanium · Canada / US  
219400442 · Titanium · Other countries  
**\$999.99**

**UPGRADE YOUR GROWL**

**AKRAPOVIČ SILENCERS TOP FEATURES**

- Deeper, more guttural sound than stock silencer.
- Meet the most stringent standards - EPA, CARB & EC certified.
- Maintain vehicle warranty requirements.
- Easy installation.
- Exhaust fit compatible with all BRP genuine accessories.



# SPYDER RT

---

ACCESSORIES



RT PASSENGER ARMRESTS 219400839



TRI AXIS ADJUSTABLE HANDLEBAR 219400344



AKRAPOVIČ SPORT TOURING 3C SILENCER 219400650 /  
OUTSIDE NORTH AMERICA: 219400442



There are a thousand ways to trick out a Spyder RT.  
Take a look at ours and let your imagination run wild.

## RT COAST-TO-COAST ADVENTURE INSPIRED LOOK



## RT LIMITED HIGHWAY MASTER INSPIRED LOOK DARK EDITION



### U-FUNCTION

- 1 ADJUSTABLE VENTED WINDSHIELD P. 78
- 2 ADJUSTABLE DRIVER BACKREST FOR PRODUCTION SEAT P. 77
- 3 ADJUSTABLE SIDE WIND DEFLECTORS P. 79

### U-STYLE

- 4 15" SHAMROCK WHEELS P. 84
- 5 MIRROR ACCENTS P. 86

### U-PERFORMANCE

- 6 AKRAPOVIČ SPORT TOURING 3C SILENCER P. 89

### U-FIT

- 1 TRI AXIS ADJUSTABLE HANDLEBAR P. 76

### U-FUNCTION

- 2 LOW WINDSHIELD KIT P. 78
- 3 COMFORT SEAT P. 77
- 4 ADJUSTABLE DRIVER BACKREST FOR COMFORT SEAT P. 77
- 5 RT PASSENGER ARMRESTS P. 77

### U-STYLE

- 6 LOW BROW FRONT FENDERS P. 85

### TRAILER

- 7 TRAILER HITCH KIT AND CONTROL MODULE P. 104

You're a click away from a custom Can-Am Spyder. Go to: [www.can-am.brp.com/spyder](http://www.can-am.brp.com/spyder) > Build & Price

You can finance all your accessories with the purchase and financing of your Can-Am Spyder RT. Ask your Can-Am Spyder dealer for all the details.





## U-FIT

### IDLER PULLEY

#### RT IDLER PULLEY SERVICE KIT

(Not illustrated)  
 · Enhances your comfort on the road by reducing vibrations generated by the belt.

**Spyder RT models 2014 and up**  
**219800419**

**\$39.99**

### HANDLEBARS

#### TRI AXIS ADJUSTABLE HANDLEBAR

- State-of-the-art adjustable handlebar reduces fatigue and delivers comfort for all riders thanks to unlimited adjustment possibilities.
- Three different axes allow you to adjust the handlebar in terms of height, width and arm distance.
- Left and right bars are linked together and rotate simultaneously during adjustment.
- Easy Allen key adjustment system.
- Handlebar reuses existing production handgrips, comodo, electrical and clutch cables, and sits directly on the stock steering column.
- GPS Support for the Tri Axis Adjustable Handlebar (219400616) sold separately.

**All Spyder RT models**

■ 219400344 - Carbon Black

**\$659.99**

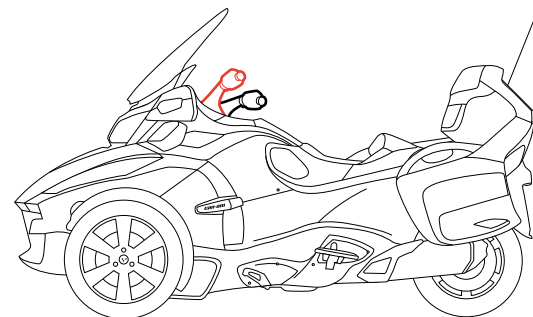

THREE DIFFERENT AXES ENABLE YOU TO ADJUST THE HANDLEBAR HEIGHT, WIDTH AND ARM DISTANCE.

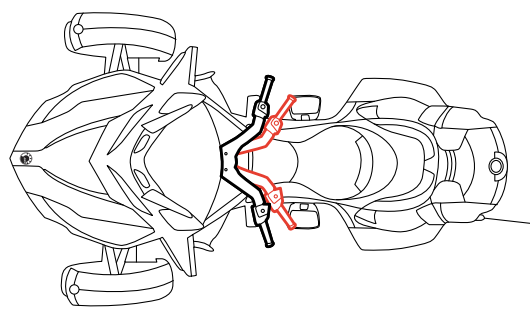

THE LEFT AND RIGHT SIDES OF THE BAR ARE LINKED SO THEY'RE ALWAYS IN SYNC.

## U-FUNCTION

### SEATS & BACKRESTS

#### NEW RT PASSENGER ARMRESTS

- The ultimate in long or short distance passenger comfort.
- Pivot up and out of the way for easy passenger access and exit.
- Styled to ensure an absolute match to your Can-Am Spyder.
- Allow easy access to passenger handles for added safety.

**All Spyder RT models**

■ 219400839 - Black

**\$349.99**



Moving the driver's seat position back just two inches (50 mm) relaxes the knees and upper body.



#### COMFORT SEAT

- Ultra comfortable with lumbar support.
- Roomier for driver, improves comfort during long rides.
- Driver backrest ready.
- Perfect for taller riders.

**All Spyder RT models**

■ 219400457 - Black

**\$659.99**



#### HEATED COMFORT SEAT

- Heated comfort seat with ability to slide in the driver backrest.
- The driver and passenger can choose their own heat intensity.
- Dual range Hi/Low heat setting.
- Activated through stock passenger and driver heated grip controls.

**Spyder RT 2014 and up**

■ 219400398 - Black

**\$919.99**

#### ADJUSTABLE DRIVER BACKREST FOR PRODUCTION SEAT

- New tilt adjustment to suit your riding style.
- Unique patent pending plug-and-go design installs in seconds and works with all standard Spyder RT driver seats with no modifications.
- Folds forward for easy passenger seat access.

**Spyder RT 2014 and up, RT 2013 and prior with 2014 and up production seats**

■ 219400679 - Black

**\$449.99**

#### ADJUSTABLE DRIVER BACKREST FOR COMFORT SEAT

- Tilt adjustment to suit your riding style.
- Unique patent pending plug-and-go design installs in seconds and works with Spyder RT driver Comfort Seats with no modification.
- Folds forward for easy passenger seat access.

**Fits with Comfort Seat (219400457)**

**Fits with Heated Comfort Seat (219400398)**

■ 219400689 - Black

**\$449.99**

#### ADJUSTABLE DRIVER BACKREST SUPPORT - UPGRADE KIT

- Kit adds tilt adjustment to previous generation driver backrests.

**For production seats**

219400682

**For Comfort seats**

219400683

**\$79.99**







**WINDSHIELDS & WIND PROTECTION**

**YOUR CLIMATE CONTROL**



**ADJUSTABLE VENTED WINDSHIELD**

- Regulates driver frontal airflow.
- Integrated adjustable vent offers easy infinite management of horizontal slats from closed to fully opened.

All Spyder RT models

25" (64 cm)  
 219400435 - Clear with chrome  
**\$409.99**

23" (58 cm)  
 219400360 - Clear with chrome  
**\$359.99**

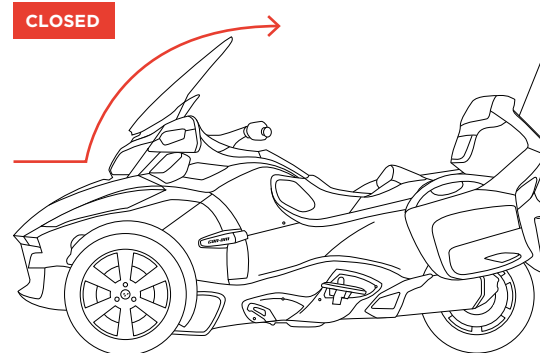
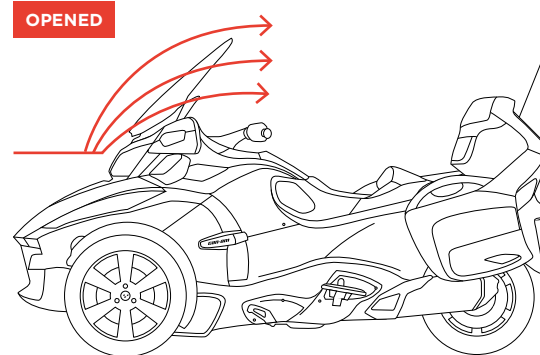

**ADJUSTABLE SIDE WIND DEFLECTORS**

- Regulate passenger and driver airflow.
- 3 preset positions (closed, parallel and inverted).
- Easy tool-less click adjustment.

All Spyder RT models

219400362 - Clear  
**\$154.99**

All Spyder RT models

219400413 - Chrome  
**\$194.99**

**3 ADJUSTABLE SIDE WIND DEFLECTORS PRESET POSITIONS**

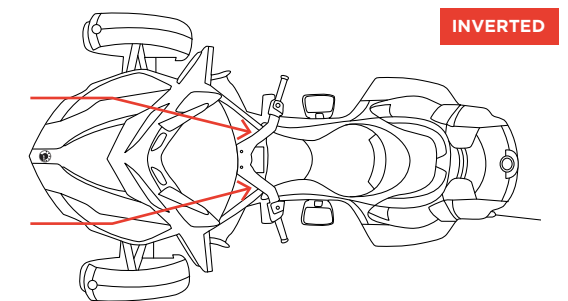
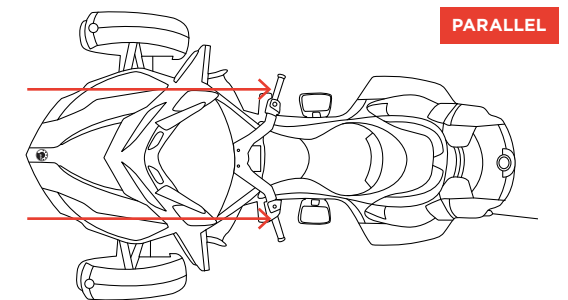
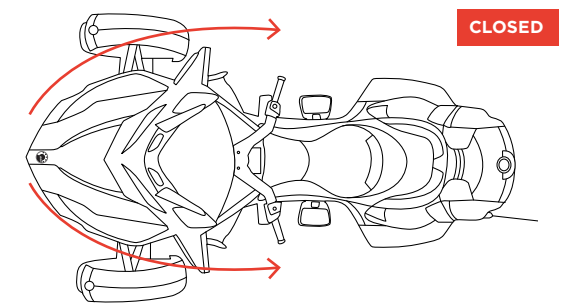

**VENTED WINDSHIELD**

- 2013-2014 standard windshield with openings.

All Spyder RT models

219400415 - Clear  
**\$309.99**



**LOW WINDSHIELD KIT**

All Spyder RT models

219400578 - Smoke  
**\$209.99**



**TOURING WINDSHIELD**

- Lower and narrower design for riders looking for less wind protection than provided by the stock Spyder RT model.

All Spyder RT models

H 25" x W 24" (64 cm x 61 cm)  
 219800199 - Clear  
**\$319.99**

H 23" x W 22" (58 cm x 56 cm)  
 219400243 - Clear  
**\$259.99**





## CARGO & STORAGE

### SEMI-RIGID REAR SIDE CARGO TRAVEL BAGS

- Stylish premium travel bags specifically sized to fit in rear side cargo.
- Retractable handle and shoulder straps for carrying convenience.
- Integrated pull tabs for effortless removal from cargo cavity.
- Sold in pairs.

All Spyder RT models  
 ■ 219400169 · Black  
**\$239.99**



### SEMI-RIGID REAR TOP CARGO TRAVEL BAG

- Stylish premium travel bag specifically sized to fit in rear top cargo.
- Retractable handle for carrying convenience.
- Integrated pull tabs for effortless removal from cargo cavity.

All Spyder RT models  
 ■ 219400168 · Black  
**\$109.99**



### TOP CASE MIRROR

- For rear top cargo cover.
- Folds open, locks up when not in use.
- Offers a small cargo in the top case lid.

All Spyder RT models  
 219400321  
**\$64.99**



### NEW INTEGRATED HELMET BAG

- Truly integrated easy-to-use helmet storage solution.
- Sturdy water-resistant construction.
- Includes elastic straps for tying down helmet bag onto seat.
- Complete with anti-theft wire for added security.

All Spyder F3 & RT models  
 ■ 219400850 · Black  
**\$59.99**



### SOFT SIDE CARGO TRAVEL BAGS

- Soft travel bags that maximize Spyder RT rear side cargo space.
- Integrated handle for carrying convenience.
- Sold in pairs.

All Spyder RT models  
 ■ 219400172 · Black  
**\$59.99**



### SOFT REAR TOP CARGO TRAVEL BAG

- Soft travel bag designed to maximize rear top cargo space.
- Integrated handle for carrying convenience.
- Rear Top Cargo Shelf (219400232) recommended for installation.

All Spyder RT models  
 ■ 219400171 · Black  
**\$54.99**



### SEMI-RIGID FRONT CARGO TRAVEL BAG

- Rolling travel bag designed to maximize available front cargo space.
- Can also double as airplane carry-on luggage.

All Spyder RT models  
 ■ 219400167 · Black  
**\$209.99**



### SOFT FRONT CARGO TRAVEL BAG

- Soft travel bag designed to maximize available front cargo space or stow in the Can-Am Freedom Trailer.
- Integrated handles for carrying convenience.
- Can also be used as a duffle bag.

All Spyder RT models, Can-Am Freedom Trailer  
 ■ 219400170 · Black  
**\$89.99**



### REAR TOP CARGO SHELF

- For supporting and organizing rear top cargo.
- Two recessed compartments to support electronic accessories.
- Can be tilted to facilitate access to lower section of cargo.

All Spyder RT models  
 ■ 219400232 · Black  
**\$54.99**

### FRONT CARGO LINER

- Felt insert provides finishing touch to front compartment.
- Features multiple storage pockets.
- Designed to integrate Front Cargo Light (219400623).

Spyder RT 2012 and prior  
 ■ 219400166 · Black  
**\$158.99**  
 Spyder RT 2013 and up  
 ■ 219400368 · Black  
**\$134.99**



### FRONT CARGO LIGHT

- Light turns on as hood opens.

All Spyder RT models  
 219400623  
**\$49.99**



### TOP CASE MOLDED INSIDE LINER

- Felt insert for finishing touch to rear top cargo compartment.

All Spyder RT models  
 ■ 219400246 · Dark Grey  
**\$129.99**





## LIGHTS & ELECTRICAL ACCESSORIES

### CELLPHONE INTERFACE KIT

- Electrical harness tucked underneath vehicle allows you to communicate with your Bluetooth cellphone via your headset.
- Requires CB & Communication System (219400611), Entertainment Harness (219400610) and Garmin Zumo 590 GPS (219400512, 219400699 EC).

**Spyder RT 2010-2017**

**219400390**

**\$114.99**



### BLUETOOTH DONGLE FOR AUDIO SYSTEM

- Allows a wireless Bluetooth connection between the vehicle's AM/FM radio (or any non-Bluetooth audio device) and the Bluetooth Communication System.
- Dual streaming to 2 Bluetooth headsets at the same time.
- Headset and AM/FM radio sold separately.

**All Spyder RT models, ST 2010-2017**

**219400458**

**\$259.99**



### GPS SUPPORT FOR TRI AXIS ADJUSTABLE HANDLEBAR

- Support for Garmin Zumo 590 GPS.
- Rotates to suit multiple adjustable handlebar settings.
- Includes casting, electric harness, rubber boot and hardware.
- GPS sold separately.

**All Spyder RT models**

**219400616 · Carbon Black**

**\$229.99**



### CB & COMMUNICATION SYSTEM

- For staying in touch with friends across a range of 40 channels.
- Handlebar controls allow push-to-talk and adjust squelch levels for maximum performance and reception quality.
- Fully integrated system also mutes radio while in transmitting and receiving modes.

**Spyder RT 2010-2017**

**219400611**

**\$839.99**



### COMMUNICATION HEADSET (WIRED)

- For rider and passenger. Includes headset and microphone.
- Works in conjunction with the CB & Communication System (219400611) available as an option on the Can-Am Spyder RT models.

**4474380090**

**\$189.99**



### PUSH-TO-TALK REMOTE FOR PASSENGER

- Passenger communication system (wired) for use with wired headsets and microphones (4474380090).
- Provides passenger with vehicle-to-vehicle communication capabilities with push-to-talk (PTT) button.
- Works in conjunction with the CB & Communication System (219400611), available as an option on the Can-Am Spyder RT models.

**4474760090**

**\$79.99**



### GARMIN ZUMO 590 GPS

- Features a glove-friendly and sunlight-readable 5" (12.7 cm) dual-orientation touchscreen display.
- Offers hands-free phone control and spoken directions heard in-helmet via Bluetooth 5 technology.
- Includes a MP3 player.
- iPod and Pandora compatibility.
- GPS Support sold separately (219400615/219400616).
- Allows control of music right on the display.
- Rugged and tough enough to withstand fuel spills, UV rays and harsh weather.
- Offers access to real-time weather and traffic information via the smartphone link app.
- Free lifetime map updates.
- Curvy Roads Routing allows rider to find winding roads.

**All Spyder models**

**219400512**

**219400699 · Europe**

**\$799.99**



### ADJUSTABLE GPS MOUNTING KIT (FOR STOCK HANDLEBAR)

(Not illustrated)

- Mounting kit for Garmin Zumo 590 GPS (219400512, 219400699 EC) with adjustable support that fits stock handlebar.
- Includes casting, electric harness, rubber boot and hardware.

**All Spyder RT models, RS, ST**

**219400615 · Carbon Black**

**\$229.99**

- The support conveniently swivels to offer the right position for all riders or light conditions.
- GPS sold separately.

### GPS SUPPORT FOR TRI AXIS ADJUSTABLE HANDLEBAR (WITHOUT HARNESS)

(Not illustrated)

**All Spyder RT models**

**219800382**

**\$59.99**

### CB ANTENNA REPLACEMENT KIT

(Not illustrated)

- Includes antenna, antenna base, ground strap and wires.

**All Spyder RT models (service kit)**

**219400317**

**\$159.99**

### ENTERTAINMENT HARNESS

(Not illustrated)

- Required to install the CB & Communication System (219400611) and Satellite Radio Kit (219400612).

**Spyder RT 2010-2017**

**219400610**

**\$129.99**

### NEW CGX3 CAMERA

- 160° wide angle lens.
- Resolution options: from 3MP up to 20MP and VGA.
- Video resolutions available: 2.7K at 30 frames per second (FPS), 720P at 120/60/30 FPS, 1080P at 60/30 FPS and VGA at 240 FPS.
- Record videos in 4K UHD at 24 FPS, 2.7K QHD at 30 FPS and 720P at 120 FPS.
- Memory: Class 10 32GB micro SD card.
- 2" capacitive touchscreen.
- Waterproof up to 32.8' (10 m) without a case.
- Li-ion battery capacity of 1050mAh, working time of 1/1.5 hours and charging time of 3 hours (2 batteries included).
- WiFi function remotely operates up to 49.2' (15 m) with mobile devices and CYCLOPS app for Android and IOS.
- Features modes such as invert, time lapse, high speed & loop recording, motion detection, capture (while recording a video), burst and anti-sharing.
- Comes with 8 mounting accessories.

**9700130090**

**\$349.99**



### SATELLITE RADIO KIT

- Receiver helps maintain radio reception everywhere.
- 150+ digital channels to choose from.
- 15 station presets for quickly tuning into your favorite programming.
- Plug-and-play system controlled via vehicle's cluster.
- Fee-based monthly subscription required.
- Entertainment Harness (219400610) required for installation.
- AM/FM Integrated Audio System (219400464) is also required for Spyder RT 2012 and prior.
- Headset sold separately.

**Spyder RT 2010-2017**

**219400612**

**\$479.99**

### 3.5 MM AUDIO PLAYER INPUT

- 3.5 mm cable for hooking up a MP3 player to top cargo's DIN connector.
- Driver volume control convenience through vehicle's cluster.

**Spyder RT 2014 and up, ST**

**710001406**

**\$36.99**



### POWER OUTLET KIT

- Recharges your electronic devices while riding\* (smartphone, MP3, heating gear, etc.).
- Dual port USB connectors.
- Plug-and-play kit.
- Simply connect under driver seat and use.
- \*The power outlet is not capable of recharging all device types while riding.

**All Spyder RT models, RS, ST, F3, F3-S**

**219400510 · USB**

· Adds an extra 12V power outlet to your vehicle.

· Conveniently located in front cargo bin.

**All Spyder models**

**219400366 · 12V**

**\$34.99**



### FOG LIGHTS

(Not illustrated)

- Enhance low beam light for better visibility at ground level and on sides.
- Uniquely styled halogen fog lamps feature a 35W bulb and clear lens with a faceted inner reflector.
- Easy installation.
- Not EC compliant.

**All Spyder RT models**

**219400579**

**\$529.99**



### CYCLOPS 360° PANORAMIC HD VIDEO CAMERA

- Features a 220-degree wide-angle lens.
- Video resolutions up to 4K at 30 frames per second.
- Professional 16MP quality photos.
- Rugged, light and portable.
- Magnetic mount for vibration-free footage and mounting to any metal surface.
- Comes with 32GB Class 10 micro SD card.
- Waterproof case up to 164' (50 m).
- Wi-Fi available to remotely control your camera from your smartphone or computer with the free CGX2 App.
- 16 modes and effects, including driving mode, loop recording, time lapse and slow motion.
- Comes with 10 mounting accessories.
- Compatible with VR goggles.

**9700020090**

**\$349.99**

### PASSENGER SPEAKER & AUDIO CONTROLS

- Weatherproof concert-sound-quality rear speaker kit including speakers, pods and passenger controls for full radio tuning.
- Plug-and-play directly into vehicle.
- Fully-equipped wiring harness included.

**Spyder RT 2012 and prior**

**219400150**

**\$159.99**



### IPOD INTEGRATION CABLE

- Cable for hooking up an iPod (30 pin connector common to Apple devices) to top cargo's DIN connector.
- Includes 5V transformer.
- Full-feature handlebar control.
- DOT-Matrix visual interface.
- Driver volume control and playlist browser convenience through vehicle's cluster.
- An adapter may be required for latest-generation iPod or iPhone.
- Standard on Spyder RT and ST Limited packages.
- Located in the front compartment on Spyder ST and in rear compartment on Spyder RT.
- Check compatibility with your dealer.

**Spyder RT 2014 and up, ST**

**710002676**

**\$71.99**

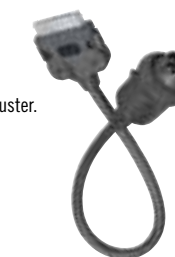

### REPLACEMENT N-TOUCH COVERS FOR COMMUNICATION SYSTEM DIN CONNECTORS

(Not illustrated)

**All Spyder RT models (service kit)**

**219400315 · Black**

**\$12.99**





## U-STYLE

### WHEELS



#### 15" SHAMROCK WHEELS

- Add personality to your Can-Am Spyder.
- Casted, painted and machined wheels.
- Sold in pairs.

**All Spyder F3 and RT models, RS, ST 2013 and up**

■ 219400500 · Deep Black  
**\$609.99**



#### 15" FAT 6 CHROME WHEELS

- Same design as Spyder F3 production wheels in PVD finish.
- Sold in pairs.

**All Spyder F3 and RT models, RS, ST 2013 and up**

■ 219400589 · Chrome  
**\$719.99**



#### CHROME REAR WHEEL

- 6-spoke PVD — chrome-like powder-coat, more resistant than regular chrome — monobloc rear wheel (hub and wheel in one piece).

**All Spyder F3 and RT models, RS, ST 2013 and up**

■ 219400574 · Chrome  
**\$659.99**

**All Spyder 2012 models and prior**

■ 219400575 · Chrome  
**\$659.99**



#### 15" 2014 RS-S MAG WHEELS

- Painted and machined.
- Sold in pairs.

**All Spyder F3 and RT models, RS, ST 2013 and up**

■ 219400418 · Carbon Black  
**\$559.99**



#### 15" RT-S FRONT WHEELS

- Premium cast aluminum 15" 12-spoke mags.
- Sold in pairs.

**All Spyder F3 and RT models, RS, ST 2013 and up**

■ 219400419 · Carbon Black  
**\$559.99**



#### 15" RT FRONT WHEELS

- 15" 12-spoke mags.
- Sold in pairs.

**All Spyder F3 and RT models, RS, ST 2013 and up**

■ 219400365 · Grey  
**\$579.99**



#### 15" RT & ST LIMITED CHROME FRONT WHEELS

- Premium cast aluminum 15" 12-spoke mags.
- Sold in pairs.

**All Spyder F3 and RT models, RS, ST 2013 and up**

■ 219400420 · Chrome  
**\$719.99**



#### 15" RS & ST FRONT WHEELS

- 15" 6-dual-spoke mags.
- Sold in pairs.

**All Spyder F3 and RT models, RS, ST 2013 and up**

■ 219400417 · Grey  
**\$559.99**



#### 14" CHROME WHEELS

- Sold in pairs.

**Spyder RT 2012 and prior**

■ 219400256 · Chrome  
**\$659.99**



#### 15" RS-S & ST-S FRONT WHEELS

- Premium cast aluminum 15" 6 twin-blade spoke mags.
- Sold in pairs.

**All Spyder RT models, RS, ST 2013 and up**  
**all Spyder F3 models**

■ 219400357 · Carbon Black  
**\$559.99**



#### 15" BLADE MAG WHEELS

- Unidirectional design (left and right wheel).
- Patented casting process allows a weight reduction of 2.2 lbs (1 kg) per wheel compared to stock wheels.
- Sold in pairs.

**All Spyder F3 and RT models, RS, ST 2013 and up**

■ 219400465 · Black  
**\$659.99**

#### 15" BLADE MAG WHEELS SERVICE KIT

(Not illustrated)

- Replacement "blade" for wheels.

■ 219400542

Left · Brushed Aluminum

■ 219400543

Right · Brushed Aluminum

**\$24.99**

#### WHEEL NUT KIT

(Not illustrated)

- Pack of 6.

**All Spyder models**

■ 219400451 · Black

**\$24.99**

■ 219400452 · Grey

**\$29.99**

### FENDERS



You can make any year Can-Am Spyder look like the latest by simply changing the fenders.



#### LOW BROW FRONT FENDERS

- Super sleek drawn steel fenders with LED position lights integrated into the front edge.
- Include electrical harness and required hardware.
- Sold in pairs.

· LED position lights not EC homologated.

**All Spyder RT models, RS, ST 2013 and up,**  
**all Spyder F3 models**

■ 219400502 · Carbon Black  
**\$949.99**



#### FRONT FENDERS

- Sporty look with a slim profile and integrated position lights and reflectors.
- Front Fender Supports (219400359) are required (sold separately).
- Sold in pairs.

**All Spyder F3 and RT models, RS, ST 2013 and up**

■ 219400423 · Pure Magnesium

■ 219400424 · Satin Black

□ 219400467 · Pearl White

**\$259.99**



#### FRONT FENDER SUPPORTS

- Supports for Front Fenders, including position lights, reflectors and hardware.
- Front Fenders sold separately.
- Sold in pairs.

**All Spyder F3 and RT models, RS, ST**

■ 219400359 · Black

**\$399.99**





**CUSTOM ACCESSORIES**



**HANDLEBAR COVER**

· Complete with hardware and black center cap.

All Spyder RT models

■ 219400263 - Chrome

**\$309.99**



**HANDLEBAR END CAPS**

· Sold in pairs.

All Spyder models

■ 219400702 - Chrome

**\$41.99**



**FOOTPEG SUPPORT CASTINGS**

· Remounting hardware included.

· Peg and footboard sets sold separately.

· Sold in pairs.

Spyder RT 2012 and prior

■ 219400268 - Chrome

**\$599.99**

**WINDSHIELD SUPPORT**

· Complete with mounting hardware.

All Spyder RT models

■ 219400298 - Chrome

**\$319.99**



**MIRROR ACCENTS**

· Chrome accents to upgrade your mirrors.

· Sold in pairs.

All Spyder RT models

■ 219400291 - Chrome

**\$99.99**



**LOWER SPOILER TRIMS**

· Sold in pairs.

Spyder RT 2013 and prior

■ 219400194 - Chrome

**\$154.99**



**SIDE CAN-AM TRIMS**

· Sold in pairs.

All Spyder RT models

■ 219400195 - Chrome

**\$84.99**



**REAR TOP CARGO TRIM**

All Spyder RT models

■ 219400192 - Chrome

**\$84.99**



**WINDSHIELD TRIM**

All Spyder RT models

■ 219400191 - Chrome

**\$64.99**



**AIR INTAKE TRIMS**

· Sold in pairs.

All Spyder RT models (except models with Fog Lights)

■ 219400196 - Chrome

**\$124.99**



**DRIVER FOOTBOARDS**

· Replace stock pegs on SE5 and SE6 models.

· Sold in pairs.

Spyder RT-S SE5, SE6 2013 and up

■ 219400582 - Chrome

**\$999.99**



**DRIVER FOOTPEGS**

· Chrome pegs assembled with rubber insulated pads.

· Mounting hardware included.

· Sold in pairs.

All Spyder RT models

■ 219400264 - Chrome

**\$204.99**



**PASSENGER FOOTBOARDS**

· Complete chrome passenger footboards assembled with rubber insulation pads.

· Mounting hardware included.

· Sold in pairs.

All Spyder RT models

■ 219400265 - Chrome

**\$279.99**



**LOWER WIND DEFLECTORS**

· Hardware included.

· Sold in pairs.

All Spyder RT models

■ 219400290 - Chrome

**\$104.99**



**UPPER WIND DEFLECTORS**

· Hardware included.

· Sold in pairs.

All Spyder RT models

■ 219400262 - Chrome

**\$104.99**



**EXHAUST TIP AND HEAT SHIELD**

· Kit for custom finishing your stock exhaust system.

· Includes chrome end pipe, heat shield and hardware.

All Spyder RT models, RS, ST, F3-T, F3 Limited

■ 219400473 - Chrome

**\$299.99**







## U-PERFORMANCE

### SHOCKS



#### FOX ADJUSTABLE FRONT SHOCK KIT

- Velocity sensitive, bolt on suspension upgrade specially tuned for Spyder RT.
- Includes stiffer springs and adjustable preload to adapt to your riding style and reduce body roll.
- Fully serviceable and rebuildable.
- Part of the Podium Performance Series, delivers great performance and comfort.

Spyder RT 2014 and up

219400588

**\$509.99**



#### ADJUSTABLE AIR REAR SUSPENSION KIT

- Upgrades suspension comfort to Spyder RT-S premium automated level.
- Includes air compressor, adjustment switch and all required hardware.
- When installing this kit on model year 2010 and 2011, an ACS switch (710001960) must be ordered to have the same blue backlight.

Spyder RT 2012 and up

219400539

**\$464.99**

### SILENCERS



All Can-Am Spyder accessory exhaust systems meet all the most stringent EPA, CARB & EC standards.



#### AKRAPOVIČ SPORT TOURING SILENCER

· Not AS certified.

Spyder RT 2013, RS, ST 2013 and up (991 engine)

219400443 · Titanium

**\$919.99**



#### AKRAPOVIČ SPORT SILENCER

· Not AS certified.

Spyder RT 2013, RS, ST 2013 and up (991 engine)

219400444 · Titanium

**\$919.99**



#### AKRAPOVIČ SPORT TOURING 3C SILENCER

- Set your ride apart with the dynamic, deep resonant sound of an Akrapovič silencer.
- Its premium titanium and carbon fiber construction is 55% lighter than stock model and it's been tested to meet the most stringent requirements.
- Not AS certified.

All Spyder RT models, F3-T, F3 Limited

219400650 · Titanium · Canada / US

219400442 · Titanium · Other countries

**\$999.99**

#### AKRAPOVIČ SILENCERS TOP FEATURES

- Innovative Design. First hexagonal shaped silencers.
- The best materials. Premium titanium shell construction with carbon fiber end cap and heat shield render these silencers 55% lighter than the stock silencer.
- The unmistakable sound of Akrapovič. Deep resonant sound that you won't hear anywhere else.
- EPA, CARB and EC certified. Rigorous measurement, testing and quality control ensure silencers meet the most stringent standards.
- Exhaust fit compatible with all BRP genuine accessories.



# SPYDER RS & ST ACCESSORIES

AKRAPOVIČ SPORT SILENCER 219400444



ULTRASPORT WINDSHIELD 219400077



TOP CASE 219400476

## U-FUNCTION

### SEATS & BACKRESTS



#### COMFORT SEAT

- Premium plush styling with stitched seat skin.
- Custom saddle look and relaxed sitting position.
- Increases driver and passenger comfort and reduces tailbone pressure.
- Ideal for driving long distances.
- Sold as complete seat assembly.
- Product may differ from picture shown.

#### Spyder RS, ST

■ 219400416 - Black

**\$509.99**



#### PASSENGER BACKREST

- One piece fixed passenger backrest with latest ergonomics, high and wide, providing superior lateral support.
- Removes in seconds back to original sport look.
- Rear cover included.

#### Spyder RS, ST

■ 219400350 - Carbon Black

**\$659.99**

### WINDSHIELDS & WIND PROTECTION

#### SPORT TOURING WINDSHIELD

- 14" (36 cm).
- Makrolon<sup>®</sup> polycarbonate custom windshield.

#### Spyder RS

□ 219400075 - Clear

**\$189.99**

#### ULTRASPORT WINDSHIELD

- 10" (25 cm).
- Makrolon polycarbonate windshield with blackened-out «V» shape profile.
- Easy installation.

#### Spyder RS

■ 219400077 - Smoke

**\$154.99**

#### ULTRA TOURING WINDSHIELD KIT

- Ultra protective windshield and casting support.
- Constructed with Quantum hardcoated 4.5 mm Lexan<sup>®</sup> polycarbonate.
- Windshield design is spaced away from pod reducing backdraft pressure.
- Service Kit (219400204) is recommended to mount this windshield.

#### Spyder RS

23" (58 cm)

□ 219400285 - Clear - Ideal for drivers under 5'10" (1.75 m).

**\$289.99**

25" (64 cm)

□ 219400336 - Clear - Ideal for drivers over 5'10" (1.75 m).

**\$309.99**

#### ULTRA TOURING WINDSHIELD SERVICE KIT

(Not illustrated)

#### Spyder RS

219400204

**\$24.99**

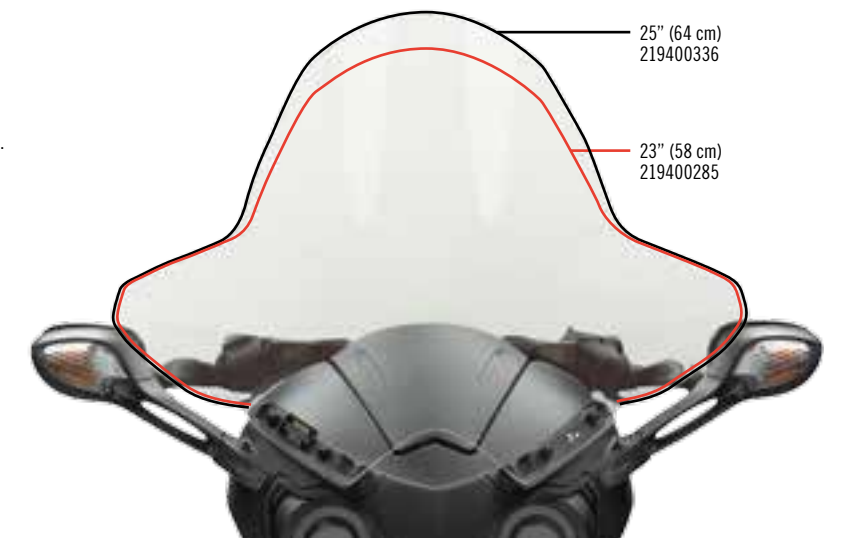
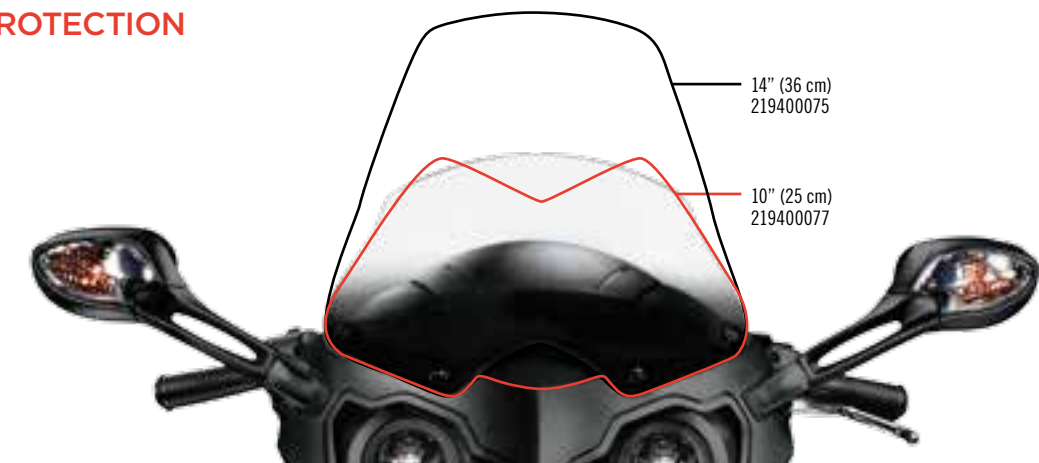





25" (64 cm)  
219400354

**ULTRA TOURING WINDSHIELD**

- Taller and slightly wider than stock windshield to ensure maximum wind protection.
- 5 height settings to adjust for more or less wind protection as needed.
- Service Kit (219800352) is recommended to mount this windshield.

**Spyder ST**  
 219400354 · Clear  
**\$279.99**

**ULTRA SPORT POD COVER**

- Sleek pod cover that provides a super sporty look by replacing the stock windshield and its adjustment mechanism.

**Spyder ST**  
 219400447 · Black  
**\$119.99**



Windshields aren't just for warmth - they play a big role in your Can-Am Spyder ST's styling.



15" (38 cm)  
219400353

**SPORT WINDSHIELD**

- Sporty look.
- 5 height settings to adjust for more or less wind protection than stock model.

**Spyder ST**  
 219400353 · Clear  
**\$194.99**



**CARGO & STORAGE**

**R-35 RIGID SADDLEBAG KIT**

- Provides carry-away convenience for additional luggage storage.
- Clean finish courtesy of fully integrated flush mount brackets with quick release system.
- Quick release quarter-turn system provides security and removal in minutes when saddlebags are not required.
- Side case utilizes Monokey® side fitting system.
- Opens/closes and attaches/detaches with one key and push button for ease of use.

**Spyder RS, ST**  
 219400351 · Black  
 219400352 · Black · Europe · EC compliant  
**\$1,119.99**

- Volume capacity of 9 US gallons (34 L) (e.g. fits 2 Can-Am full face helmets).
- Weight capacity of 15 lbs (6.8 kg) each side.
- Dimensions W 21" x D 12" x H 15.5" (53 cm x 30 cm x 39 cm).
- Kit includes 2 saddlebags.
- Color-matched panels sold separately.
- Standard on Spyder ST Limited package.



Unlike competing saddlebags, Can-Am Spyder saddlebags ensure you maintain your vehicle's warranty.



**R-35 SADDLEBAG PANEL KIT**

- Sold in pairs.
- EC compliant.

**Spyder RS, ST**  
 219400174 · Yellow  
 219400175 · Roadster Red  
 219400178 · Full Moon Silver  
 219400222 · Pearl White  
 219400292 · Pure Magnesium  
 219400293 · Alloy Orange

219400375 · Can-Am Red  
 219400377 · Steel Black Metallic  
 219400461 · Circuit Yellow  
**\$134.99**

**TOP CASE**

- Rear luggage that mounts directly on Passenger Backrest (219400350), sold separately.
- 8.7 US gallons (33 L) capacity.
- Installs and removes in minutes.

**Spyder ST**  
 219400476 · Black  
**\$509.99**



**PASSENGER SEAT BAG**

- 5.9 US gallons (22.3 L) capacity.
- Durable 1200-denier nylon construction with polyurethane coating.
- For use on passenger seat, also fits in front storage compartment.

**Spyder RS, ST**  
 280000320 · Dark Grey  
**\$144.99**



**ROLLING TRAVEL BAG**

- Premium bag with extendable handle.
- Fits conveniently in front storage compartment.

**Spyder RS, ST**  
 219400098 · Grey  
**\$209.99**



**R-35 SADDLEBAG REAR REFLECTOR KIT**

(Not illustrated)  
**Spyder RS, ST (service kit)**  
 219400235  
**\$13.99**



## LIGHTS & ELECTRICAL ACCESSORIES



FOG LIGHTS

WITHOUT THE FOG LIGHTS

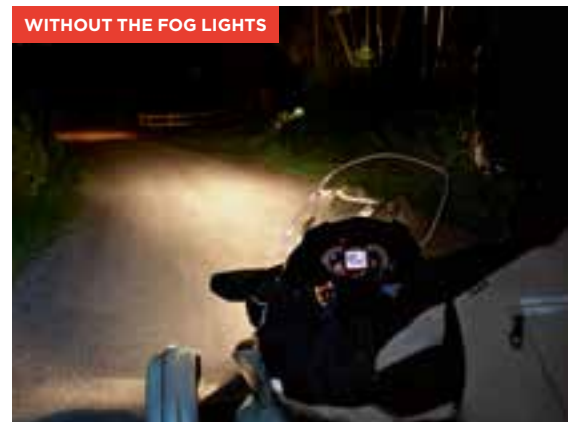

WITH THE FOG LIGHTS

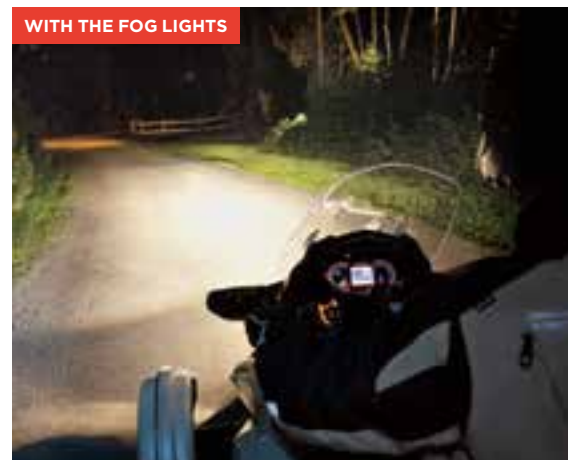

### FOG LIGHTS

- Enhance low beam light for better visibility at ground level and on sides of your vehicle.
- Uniquely styled halogen fog lamps feature a 35W bulb and clear lens with a faceted inner reflector.
- Harness included.
- Easy installation.
- Not compatible with EC homologated vehicles.
- Not EC compliant.

**Spyder RS, ST 2013 and up**

219400614

**\$409.99**

### GARMIN ZUMO 590 GPS

- Features a glove-friendly and sunlight-readable 5" (12.7 cm) dual-orientation touchscreen display.
- Offers hands-free phone control and spoken directions heard in-helmet via Bluetooth 5 technology.
- Includes a MP3 player.
- iPod and Pandora compatibility.
- Allows control of music right on the display.

**All Spyder models**

219400512

219400699 - Europe

**\$799.99**

- Rugged and tough enough to withstand fuel spills, UV rays and harsh weather.
- Offers access to real-time weather and traffic information via the smartphone link app.
- Free lifetime map updates.
- Curvy Roads Routing allows rider to find winding roads.
- Adjustable GPS Mounting Kit (219400615) sold separately.



### ST RADIO KIT

- (Not illustrated)
- Easy access handlebar controls, menu driven display. Kit includes radio module, antenna and 2 front speakers.

**Spyder ST**

219400521

**\$859.99**



### NEW CGX3 CAMERA

- 160° wide angle lens.
- Resolution options: from 3MP up to 20MP and VGA.
- Video resolutions available: 2.7K at 30 frames per second (FPS), 720P at 120/60/30 FPS, 1080P at 60/30 FPS and VGA at 240 FPS.
- Record videos in 4K UHD at 24 FPS, 2.7K QHD at 30 FPS and 720P at 120 FPS.
- Memory: Class 10 32GB micro SD card.
- 2" capacitive touchscreen.
- Waterproof up to 32.8 (10 m) without a case.
- Li-ion battery capacity of 1050mAh, working time of 1/1.5 hours and charging time of 3 hours (2 batteries included).
- WiFi function remotely operates up to 49.2' (15 m) with mobile devices and CYCLOPS app for Android and IOS.
- Features modes such as invert, time lapse, high speed & loop recording, motion detection, capture (while recording a video), burst and anti-sharing.
- Comes with 8 mounting accessories.

9700130090

**\$349.99**



### CYCLOPS 360° PANORAMIC HD VIDEO CAMERA

- Features a 220-degree wide-angle lens.
- Video resolutions up to 4K at 30 frames per second.
- Professional 16MP quality photos.
- Rugged, light and portable.
- Magnetic mount for vibration-free footage and mounting to any metal surface.
- Comes with 32GB Class 10 micro SD card.
- Waterproof case up to 164' (50 m).
- Wi-Fi available to remotely control your camera from your smartphone or computer with the free CGX2 App.
- 16 modes and effects, including driving mode, loop recording, time lapse and slow motion.
- Comes with 10 mounting accessories.
- Compatible with VR goggles.

9700020090

**\$349.99**



### ADJUSTABLE GPS MOUNTING KIT (FOR STOCK HANDLEBAR)

- Mounting kit for Garmin Zumo 590 GPS (219400512, 219400699 EC) with adjustable support that fits stock handlebar.
- Includes casting, electric harness, rubber boot and hardware.
- The support conveniently swivels to offer the right position for all riders or light conditions.
- GPS sold separately.

**All Spyder RT models, RS, ST**

219400615 - Carbon Black

**\$229.99**



### HEATED DRIVER GRIPS

- Complete driver heating kit with variable intensity control.
- Provide extra warmth during cooler riding season.

**Spyder ST**

219400613

**\$229.99**



### BLUETOOTH DONGLE FOR AUDIO SYSTEM

- Allows a wireless Bluetooth connection between the vehicle's AM/FM radio (or any non-Bluetooth audio device) and the Bluetooth Communication System.
- Dual streaming to 2 Bluetooth headsets at the same time.
- Headset and AM/FM radio sold separately.

**All Spyder RT models, ST 2013 and up**

219400458

**\$259.99**



### POWER OUTLET KIT

- Recharges your electronic devices while riding\* (smartphone, MP3, heating gear, etc.).
  - Dual port USB connectors.
  - Plug-and-play kit.
  - Simply connect under driver seat and use.
- \*The power outlet is not capable of recharging all device types while riding.

**All Spyder RT models, RS, ST, F3, F3-S**

219400510 - USB

· Adds an extra 12V power outlet to your vehicle.

· Conveniently located in front cargo bin.

**All Spyder models**

219400366 - 12V

**\$34.99**



### IPOD INTEGRATION CABLE

- Cable for hooking up an iPod (30 pin connector common to Apple devices) to top cargo's DIN connector.
- Includes 5V transformer.
- Full-feature handlebar control.
- DOT-Matrix visual interface.
- Driver volume control and playlist browser convenience through vehicle's cluster.
- An adapter may be required for latest-generation iPod or iPhone.
- Standard on Spyder RT and ST Limited packages.
- Located in the front compartment on Spyder ST and in rear compartment on Spyder RT.
- Check compatibility with your dealer.

**Spyder RT 2014 and up, ST**

710002676

**\$71.99**



### 3.5 MM AUDIO PLAYER INPUT

- 3.5 mm cable for hooking up a MP3 player to top cargo's DIN connector.
- Driver volume control convenience through vehicle's cluster.
- Located in the front compartment on Spyder ST and in rear top cargo on Spyder RT.

**Spyder RT 2014 and up, ST**

710001406

**\$36.99**





**★ U-STYLE**

**WHEELS**



**15" 2014 RS-S MAG WHEELS**  
 · Painted and machined.  
 · Sold in pairs.  
 · Standard on 2014 Spyder RS-S package.  
All Spyder F3 and RT models, RS, ST 2013 and up  
 ■ 219400418 · Carbon Black  
**\$559.99**



**15" RT-S FRONT WHEELS**  
 · Premium cast aluminum 15" 12-spoke mags.  
 · Sold in pairs.  
All Spyder F3 and RT models, RS, ST 2013 and up  
 ■ 219400419 · Carbon Black  
**\$559.99**



**15" RT FRONT WHEELS**  
 · 15" 12-spoke mags.  
 · Sold in pairs.  
All Spyder F3 and RT models, RS, ST 2013 and up  
 ■ 219400365 · Grey  
**\$579.99**



**15" RS-S & ST-S FRONT WHEELS**  
 · Premium cast aluminum 15" 6 twin-blade spoke mags.  
 · Sold in pairs.  
All Spyder F3 and RT models, RS, ST 2013 and up  
 ■ 219400357 · Carbon Black  
**\$559.99**



**15" RT & ST LIMITED CHROME FRONT WHEELS**  
 · Premium cast aluminum 15" 12-spoke mags.  
 · Sold in pairs.  
All Spyder F3 and RT models, RS, ST 2013 and up  
 ■ 219400420 · Chrome  
**\$719.99**



**15" RS & ST FRONT WHEELS**  
 · 15" 6-dual-spoke mags.  
 · Sold in pairs.  
All Spyder F3 and RT models, RS, ST 2013 and up  
 ■ 219400417 · Grey  
**\$559.99**



**15" BLADE MAG WHEELS**  
 · Unidirectional design (left and right wheel).  
 · Patented casting process allows a weight reduction of 2.2 lbs (1 kg) per wheel compared to stock wheels.  
 · Sold in pairs.  
All Spyder F3 and RT models, RS, ST 2013 and up  
 ■ 219400465 · Black  
**\$659.99**



**15" SHAMROCK WHEELS**  
 · Add personality to your Can-Am Spyder.  
 · Casted, painted and machined wheels.  
 · Sold in pairs.  
All Spyder F3 and RT models, RS, ST 2013 and up  
 ■ 219400500 · Deep Black  
**\$609.99**



**15" FAT 6 CHROME WHEELS**  
 · Same design as Spyder F3 production wheels in PVD finish.  
 · Sold in pairs.  
All Spyder F3 and RT models, RS, ST 2013 and up  
 ■ 219400589 · Chrome  
**\$719.99**

**15" BLADE MAG WHEELS SERVICE KIT**  
 (Not illustrated)  
 · Replacement "blade" for wheels.  
 ■ 219400542 · Left · Chrome  
 ■ 219400543 · Right · Chrome  
**\$24.99**

**CHROME REAR WHEEL**  
 · 6-spoke PVD - chrome-like powder-coat, more resistant than regular chrome - monobloc rear wheel (hub and wheel in one piece).  
All Spyder F3 and RT models, RS, ST 2013 and up  
 ■ 219400574 · Chrome  
All Spyder 2012 models and prior  
 ■ 219400575 · Chrome  
**\$659.99**



**WHEEL NUT KIT**  
 (Not illustrated)  
 · Pack of 6.  
All Spyder models  
 ■ 219400451 · Black  
**\$24.99**  
 ■ 219400452 · Grey  
**\$29.99**





**FRONT FENDERS**

- Sporty look with a slim profile and integrated position lights and reflectors.
- Front Fender Supports (219400359) are required (sold separately).
- Sold in pairs.

**All Spyder F3 and RT models, RS, ST 2013 and up**

- 219400423 - Pure Magnesium
- 219400424 - Satin Black
- 219400467 - Pearl White

**\$259.99**



**LOW BROW FRONT FENDERS**

- Super sleek drawn steel fenders with LED position lights integrated into the front edge.
- Include electrical harness and required hardware.
- LED position lights not EC homologated.
- Sold in pairs.

**All Spyder F3 and RT models, RS, ST 2013 and up**

- 219400502 - Carbon Black

**\$949.99**



**SPORT REAR FENDER**

- Provides a pure sport look while showing off the massive rear tire girth for an awesome visual.
- Includes fender, lateral covers, license plate relocater and light.
- Not EC homologated.

**Spyder RS, ST**

- 219400400 - Black

**\$299.99**



**FRONT FENDER SUPPORTS**

- Supports for Front Fenders, including position lights, reflectors and hardware.
- Front Fenders sold separately.
- Sold in pairs.

**All Spyder RT models, RS, ST**

- 219400359 - Black

**\$399.99**



**MIRROR ACCENTS**

- Replace stock mirror accents.
- Sold in pairs.

**Spyder ST**

- 219400401 - Chrome

**\$99.99**

**EXHAUST TIP AND HEAT SHIELD**

- Kit for custom finishing your stock exhaust system.
- Includes chrome end pipe, heat shield and hardware.

**All Spyder RT models, RS, ST, F3-T, F3 Limited**

- 219400473 - Chrome

**\$299.99**



MIRROR ACCENTS

WINDSHIELD TRIMS

UPPER WIND DEFLECTORS

**UPPER WIND DEFLECTORS**

- Replace stock clear upper wind deflectors.

**Spyder ST**

- 219400386 - Chrome

**\$104.99**

**WINDSHIELD TRIMS**

- Sold in pairs.

**Spyder ST, F3, F3-S**

- 219400355 - Chrome

**\$84.99**

**HANDLEBAR END CAPS**

- Sold in pairs.

**All Spyder models**

- 219400702 - Chrome

**\$41.99**



**PROMOTIONAL STICKERS**

- Multi-use vinyl stickers.
- Ideal for showing your Can-Am Spyder colors everywhere you go.
- Sold in pack of 4.

**219400099**

**\$24.99**







 **U-PERFORMANCE**

**SHOCKS**

**FOX ADJUSTABLE SHOCK KIT WITH SWAY BAR**

- Fully adjustable gas-charged front FOX Podium 5.7" (145 mm) racing shocks.
- Kit complete with a high performance sway bar.

Spyder RS, ST 2013

219400409

Spyder RS 2011-2012

219400403

**\$409.99**



**UPGRADE YOUR GROWL**

**AKRAPOVIČ SILENCERS TOP FEATURES**

- Innovative Design. First hexagonal shaped silencers.
- The best materials. Premium titanium shell construction with carbon fiber end cap and heat shield render these silencers 55% lighter than the stock silencer.
- The unmistakable sound of Akrapovič. Deep resonant sound that you won't hear anywhere else.
- EPA, CARB and EC certified. Rigorous measurement, testing and quality control ensure silencers meet the most stringent standards.
- Exhaust fit compatible with all BRP genuine accessories.

**SILENCERS**

**AKRAPOVIČ SPORT TOURING SILENCER**

· Not AS certified.

Spyder RT 2013, RS, ST 2013 and up (991 engine)

■ 219400443 · Titanium

**\$919.99**



**AKRAPOVIČ SPORT SILENCER**

· Not AS certified.

Spyder RT 2013, RS, ST 2013 and up (991 engine)

■ 219400444 · Titanium

**\$919.99**





# CAN-AM FREEDOM TRAILER



## PUT LONG DISTANCE WORRIES BEHIND YOU.

Advanced technology, design and bold styling come together to deliver an exceptional trailering experience – so you can head out with everything you need for as long as you want.



### CAN-AM FREEDOM TRAILER

All Spyder RT models, ST, F3-T, F3 Limited

000T1HA00 - Black

\$3,199.99

**"THE CAN-AM FREEDOM TRAILER IS A HANDS-DOWN WINNER IN FEATURES AND PERFORMANCE OFFERED AT THIS PRICE."**

— Fred Rau, Can-Am Spyder Ambassador and enthusiast

- Independent suspension with coil-over shocks and low trailer floor provide a stable, smooth ride.
- Can-Am Spyder RT, ST, F3-T and F3 Limited Vehicle Stability System adapt to the trailer.
- Hinged lid opens wide for easy loading.
- Lid opens with one hand and stays open with air-spring assist.
- Interior's flat bottom and optimized shape maximize capacity. Capacity: 20 ft<sup>3</sup>/566 L.
- Easily holds enough for two travellers, or two golf bags.
- The only trailer that maintains vehicle factory warranty.

**2-YEAR WARRANTY**





**TRAILER STORAGE COVER**

- 100% Polyester with integrated storage pocket.
- Product may differ from picture shown.

**Can-Am Freedom Trailer**  
 ■ 219400592 · Black

**\$144.99**

**NEW CONTROL MODULE HARNESS SERVICE KITS**

(Not illustrated)

- Allows installation of the Trailer Hitch (219400519) and the Trailer Hitch and Control Module (219400432).

**Spyder F3-T, F3 Limited, RT 2018**

219400853

**\$39.99**

- Allows installation of the Trailer Hitch Kit and Control Module (219400854).

**Spyder RT 2010 - 2017**

219400893

**\$39.99**

- Allows installation of the Trailer Hitch (219400852).

**Spyder F3-T, F3 Limited 2016-2017**

219400855

**\$39.99**

**TRAILER HITCH KIT AND CONTROL MODULE**

- Heavy-duty trailer hitch specifically designed for use in conjunction with Can-Am Freedom Trailer.
- Patent pending impact-absorbing mechanical design ensures maximum trailer and vehicle performance.
- Meets all stringent vehicle safety requirements.
- Integrated mud flap reduces damage from rock chips and other debris.
- Wiring components and full-function light control module included.
- Installs and removes easily.
- Only system on the market that maintains vehicle warranty requirements.

**Spyder RT 2010 - 2017**

219400432

**\$529.99**

**Spyder RT 2018**

219400854

**\$569.99**

**Spyder ST**

219400431

**\$569.99**

**Spyder F3-T, F3 Limited 2016-2017**

219400519

**\$569.99**

**Spyder F3-T, F3 Limited 2018**

219400852

**\$569.99**



**FREEDOM TRAILER PREMIUM CHROME TRIMS**

- Made of high quality ABS thermoplastic.
- Contains left (1), right (1) and rear (1) trims.
- Rubber molding to protect trailer paint included.

**Can-Am Freedom Trailer**

■ 219400587 · Chrome

**\$289.99**

**TRAILER TONGUE STAND**

(Not illustrated)

- Keeps trailer leveled when not hitched to vehicle.

**Can-Am Freedom, RT-622 Trailers**

219400190

**\$99.99**



**4-PIN TRAILER ADAPTOR HARNESS**

- Designed to convert the trailer's electrical harness into a standard 4-pin trailer connector for automotive use.

**Can-Am Freedom, RT-622 2013-2014 Trailers**

219400437

**\$79.99**



**PREMIUM CARPET**

- Crafted from virtually indestructible thermoplastic.
- Computer-cut for a precision fit in your vehicle.

**Can-Am Freedom Trailer**

219400538

**\$259.99**



**SPARE WHEEL TIRE BAG**

- Spare tire transportation bag with integrated clipping system to secure tire in trailer.

**Can-Am Freedom, RT-622 Trailers**

■ 219400307 · Black

**\$59.99**

**CAN-AM FREEDOM TRAILER STRIPE DECAL KIT**

- Premium stripe decals add a sporty look to match the Freedom Trailer to your Can-Am Spyder.

**Can-Am Freedom Trailer**

■ 219400669 · Can-Am Red

■ 219400671 · Gloss White

■ 219400672 · Intense Red

■ 219400674 · Magma Red

■ 219400675 · Matte Black

■ 219400676 · Pure Magnesium

■ 219400677 · Satin Silver

■ 219400678 · Vegas White Pearl

■ 219400693 · Orbital Blue

**\$249.99**





# COVERS

## SPYDER F3

### F3-T TRAILERING COVER

- Made of durable, 100% waterproof, fully-breathable 300-denier polyester.
- Easy-on / easy-off system ensures cover is secure in all trailering conditions.
- Equipped with integrated exhaust panel and no-scratch flannel windshield liner.
- Compatible with all stock and accessory regardless of passenger or driver backrest, passenger armrest, or windshields.
- Incompatible with top case.

**Spyder F3-T, F3 Limited 2016**

■ 219400751 · Black

**\$229.99**



### F3 LIMITED TRAILERING COVER

- Made of durable, 100% waterproof, fully-breathable 300-denier polyester.
- Easy-on / easy-off system ensures cover is secure in all trailering conditions.
- Equipped with integrated exhaust panel and no-scratch flannel windshield liner.
- Compatible with all stock and accessory seats regardless of passenger or driver backrest, passenger armrest, windshield, or top case.

**F3-T (with optional top case), F3 Limited 2017 & up**

■ 219400768 · Black

**\$249.99**



### DRIVER SEAT RAIN COVER

- 100% waterproof driver-seat protection.
- Fits all stock or accessory seats.
- Compatible with Driver Backrest.
- Quick installation and removal.

**All Spyder F3 models**

■ 219400648 · Black

**\$39.99**



### OUTDOOR COVER

- Durable solution-dyed UV and mildew-resistant 100-denier polyester construction.
- Soft inner liner protects windshields up to Tall Boy Windshield (219400596).
- Compatible with F3-T with or without passenger and driver backrests.
- Also compatible with all F3 windshields.
- Incompatible with passenger armrests (219400726).

**Spyder F3-T, F3 Limited 2016**

■ 219400603 · Black

**\$259.99**



### TRAVEL COVER

- Start your morning ride with a dry, clean seat.
- Protects the top surfaces of your vehicle and stows compactly in the front compartment, making it a great road trip companion.

**Spyder F3-T, F3 Limited 2016**

■ 219400604 · Black

**\$159.99**



### PASSENGER SEAT RAIN COVER

- 100% waterproof passenger seat protection.
- Fits all stock or accessory seats.
- Compatible with Passenger Backrest and Short Rail.
- Quick installation and removal.

**Spyder F3, F3-S and F3-T standard seat, Coast-to-coast Seat, Cannonball seat**

■ 219400649 · Black

**\$34.99**



### OUTDOOR COVER

- Durable solution-dyed UV and mildew-resistant 100-denier polyester construction.
- Inner liner protects windshield.
- Easy maintenance.

**Spyder F3, F3-S**

■ 219400495 · Black

**\$229.99**



### TRAVEL COVER

- Provides protection to vehicle's top areas.
- Stows conveniently into front bin and takes up little space.
- Easy to install and remove.

**Spyder F3, F3-S**

■ 219400496 · Black

**\$164.99**



## SPYDER RT



### SEAT RAIN COVER

- 100% waterproof seat protection.
- Fits all stock or accessory seats.
- Compatible with Driver Backrest.
- Quick installation and removal.

**All Spyder RT models**

■ 219400722 · Black

**\$99.99**



### TRAVEL COVER

- Provides protection to vehicle's top areas (windshield, seat, top cargo).
- Stows conveniently into top cargo and takes up little space.
- Quick installation and removal.

**All Spyder RT models**

■ 219400199 · Black

**\$114.99**



### NEW CUSTOM VEHICLE COVER

- Made of tough water-repellent, breathable 300-denier polyester.
- This cover provides maximum vehicle protection while trailering or outdoor storing.
- Includes integrated exhaust panel and protective flannel windshield liner.
- Easy attach system secures cover in all trailering conditions.
- Compatible with RT Passenger Armrests (219400839).

**All Spyder RT models**

■ 219400860 · Black

**\$249.99**

## SPYDER RS & ST



### LIGHT TRAVEL COVER

- Provides vehicle's seating, handlebar and windshield areas with outdoor temporary/overnight protection.
- Compact size makes it convenient for traveling.

**Spyder RS**

■ 219400275 · Black

**\$144.99**

**Spyder RS, ST**

■ 219400449 · Black

**\$159.99**



### INDOOR STORAGE COVER

- Soft, non-abrasive, breathable polyester construction allows condensation to escape when vehicle is in storage.
- Easy clean fabric with Scotchgard® treatment.

**Spyder RS**

■ 280000338 · Black

**\$159.99**



### OUTSIDE STORAGE COVER

- Durable solution-dyed UV and mildew-resistant 100-denier polyester construction.
- Inner liner protects hood and windshield.
- Easy maintenance.
- Fits models with Ultra Touring Windshields (219400306/ 219400354) and Passenger Backrest (219400350).

**Spyder RS, ST**

■ 219400448 · Black

**\$209.99**



### TIE-DOWN KIT

- Specifically designed to secure your Can-Am Spyder while trailering.
- Attach your vehicle to 3 or 4 anchor points, depending on your trailer.
- Pack of 4.

**219400200**

**\$114.99**



# GENUINE BRP PARTS.

BY USING ORIGINAL BRP PARTS,  
YOU ARE TAKING CARE OF YOUR INVESTMENT.  
MAKE THE RIGHT CHOICE.



## AIR FILTERS

- Prevent airborne contaminants from reaching your engine.
- Protect internal components against premature wear.

### Spyder RS 2008-2012

707800188

**\$32.99**

### Spyder RS 2013 and up, Spyder RT with 998 cc engine 2010-2013, all Spyder ST models

707800306

**\$39.99**

### All Spyder models with 1330 engine

707800483

**\$33.99**

## BRAKE PAD KITS

- Brembo® brake systems are considered to be the benchmark for quality and innovation, delivering the ultimate in performance, comfort, quiet, and durability.

### Spyder 2013 and up

219800237 - Front

219800239 - Rear

**\$59.99**

- Provide excellent performance, quiet, and durability in all road conditions.

### Spyder 2012 and prior

219800164 - Front

**\$119.99**

219800165 - Rear

**\$59.99**

## TIRES

- Designed to work in tandem with the Can-Am Spyder innovative Vehicle Stability System to provide an ultra-stable, confident ride.

706202317 - Front - 165/55R 15

706201411 - Front - 165/65R 14

**\$94.99**

705501464 - Rear - 225/50R 15

**\$189.99**

## YUASA® BATTERIES

- Absorbed Glass Mat (AGM) technology offers durability, electrical reliability, near maintenance-free performance, making it ideal for the Can-Am Spyder.
- Spill-proof design with the ability to hold its charge three times longer and than conventional lead-acid batteries in stand-by mode.

410922962 - 21 Amps (YTX24HL)

**\$142.99**

## NGK® SPARK PLUGS

- NGK spark plugs are recommended by BRP and ensure your Can-Am Spyder's ROTAX engine runs smoothly and delivers optimum power at all times.
- Consistent, reliable performance make it an OEM favorite.

415129670 - MR7BI-8

**\$21.22**

219800231 - KR8Bi

**\$20.37**

278002297 - DCP-R9E

**\$3.99**

707000246 - DCP-R8E

**\$3.99**

## DRIVE BELTS

- High-tensile strength carbon cord and HNBR rubber construction delivers impressive durability, superior flexibility and reduced noise, while resisting abrasion.
- Tooth-side fabric composed of special low-friction fiber.

### Spyder RT 2014 and up

705501304

**\$309.99**All Spyder F3 models

705502157





XPS ENGINE OILS



**XPS 4-STROKE SYNTHETIC OIL (0W40)**

- The best all-year-long choice for any BRP vehicle with a 4-stroke engine.
- Full-synthetic formula made from premium oil base stocks.
- Performs consistently throughout a broad temperature range.
- Tested and proven by BRP engineers to offer the best engine protection where its use is specified.
- Wet clutch compatible.
- Protects against corrosion and rust.
- Ambient temperature operating range +40°C/+104°F to -45°C/-49°F.

779139 · 1 quart / 946 ml      779140 · 1 US gallon / 3.785 L  
779214 · Europe                  779199 · Europe



**XPS 4-STROKE SYNTHETIC BLEND OIL (5W40)**

- The warm-weather choice for any BRP vehicle with a 4-stroke engine.
- Synthetic blend formula made from premium oil base stocks.
- Performs consistently throughout a broad temperature range.
- Tested and proven by BRP engineers to offer the best engine protection where its use is specified.
- Wet clutch compatible.
- Protects against corrosion and rust.
- Ambient temperature operating range +40°C/+104°F to -35°C/-31°F.

779133 · 1 quart / 946 ml                  779134 · 1 US gallon / 3.785 L  
779202 · Europe                              779204 · Europe



**XPS OIL CHANGE KIT**

- Ultra-convenient "all-in-one" oil change kit saves time and money.
- Includes XPS Synthetic or Synthetic Blend Oil, oil filter, o-rings and washer.

**SM5**    **SE5**  
219800262 · Synthetic                          219800263 · Synthetic  
**SM6, SE6**  
219800356 · Synthetic



XPS CLEANERS

**XPS ROADSTER CLEANING AND DETAILING KIT**

- Everything needed for care and cleaning.
- Includes multi-surface XPS Metal Polish, degreasing XPS Roadster Wash, showroom shine XPS Spray Cleaner & Polish, super absorbent and machine washable XPS Microfiber Towels.

219702872  
\$43.99



XPS MAINTENANCE PRODUCTS

**XPS BRAKE FLUID**

- Meets or exceeds all DOT3 and DOT4 brake fluid requirements.
- High-temperature formula resists fade, and also conditions seals and o-rings in braking system.

779151 · 12 oz. / 344 ml  
\$9.99



**XPS CARBON FREE FUEL TREATMENT**

- Combination of a fuel treatment and a fuel system cleaner that can be used periodically to restore lost starting or throttle performance, as well as maintain fuel system integrity and keep internal engine parts clean.
- It treats fuel for storage and addresses the moisture problems inherent in today's Ethanol-blended fuels, keeping ferrous and soft metal parts clean and free of corrosion.
- Uses patented, state-of-the-art additives.
- Cleans valves, sticky rings and combustion chamber.

779169 · 12 oz. / 355 ml  
779220 · Europe  
\$8.99



**XPS FUEL STABILIZER**

- Ethanol-compatible and will stabilize fuel in your tank to keep it from breaking down and causing hard starting, throttle hesitation and poor run quality.
- Ethanol attracts moisture, and this product contains powerful anti-corrosion additives to protect fuel system components.
- Prevents problems associated with E10 fuels.

779171 · 8 oz. / 240 ml  
779183 · Europe  
\$9.99



**XPS BRAKES & PARTS CLEANER**

- A concentrated blend of solvents with a powerful blasting spray that effectively removes grease, grime, brake fluid and other contaminants from brake components and metal parts without the need for disassembly.
- Evaporates instantly and completely, leaving no residue to hinder performance.
- Contains no ozone depleters.

219701705 United States  
\$7.99



**XPS ROADSTER WASH**

- A biodegradable non-toxic cleaner that removes dirt and road grime better than any other cleaner.
- Simply spray on and rinse off.
- When used as directed, XPS Roadster Wash is safe for all roadster finishes.

219701703  
\$10.99



**XPS METAL POLISH**

- Cleans, polishes and protects most metal surfaces, such as chrome, stainless steel, nickel, aluminum, brass, bronze, copper, platinum, magnesium and more.
- Not recommended for use on anodized or clear-coated finishes.

219701707  
779183 · Europe  
\$14.99



**XPS SUSPENSION GREASE**

- Designed to work specifically with the components found in Can-Am vehicles suspensions.
- It is highly stable and offers optimal lubrication at both extreme cold and high temperatures while protecting suspension components from dirt and moisture, as well as corrosion under extreme washout conditions.

779163 · 14 oz. / 397 g  
\$10.99



**XPS PRE-MIXED ANTIFREEZE/COOLANT**

- XPS Antifreeze/Coolant contains the correct dilution and the necessary additives to prevent corrosion and inhibit cavitation in BRP cooling systems.
- Long-life, 5-year formula specially formulated for BRP vehicles.
- Superior heat transfer.
- Ideal replacement for vehicles that normally use a 2-year antifreeze/coolant (green).
- 5 years (orange)

779150 · 1 quart / 946 ml  
\$9.99



**XPS SPRAY CLEANER & POLISH**

- Removes dirt, grease, road grime and water marks easily and quickly.
- Non petroleum based formula will not harm plastic finishes.

219702844 · 12 oz. / 340 g  
\$9.99



**XPS MICROFIBER TOWELS**

- The latest in high-quality detailing towels.
- Made up of extremely fine fibers, their soft surfaces have been perfected for drying and polishing painted, gel coated and hard shiny surfaces.
- They are so absorbent they hold up to seven times their weight in water.
- Machine washable means they can be used over and over again.

· Pack of 2.  
219701759  
\$8.99



\* Please contact your Can-Am Spyder dealer for suggested retail prices of oil based products.



# CHART NEW TERRITORY

## You know who you are.

You're road-trip ready and always eager to head out for a ride you'll never forget. You're all about a breathtaking adventure. Which is why you need products that meet your expectations and then some. XPS oils and lubricants answer the call. Specifically designed to optimize high performance, reliability, and long engine life for your Can-Am Spyder, XPS was developed right alongside Rotax engines. Passing the highest levels of testing; unparalleled in all conditions. Feel free on the open road. Begin your next journey at your BRP dealer.



The XPS logo, consisting of the letters 'XPS' in a stylized, italicized, white font with a black outline.